



目录	页面	Contents	Page
F系列平行轴斜齿轮减速机		<b>F Series Parallel Shaft Gear Motor and gear unit</b>	
产品外形	144-144	<b>Products Figure</b>	<b>144-144</b>
型号标记	145-145	<b>Designation</b>	<b>145-145</b>
电机配置说明	145-146	<b>Configuration</b>	<b>145-146</b>
安装位置	147-148	<b>Mounting Position</b>	<b>147-148</b>
技术参数	149-201	<b>Technical Data</b>	<b>149-201</b>
安装尺寸	202-245	<b>Mounting Dimensions</b>	<b>202-245</b>



产品外形

Products Figure

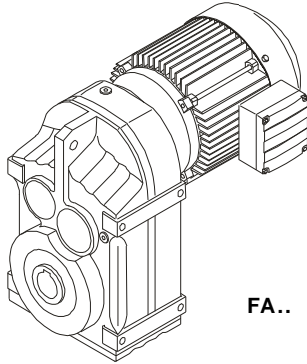

FA..

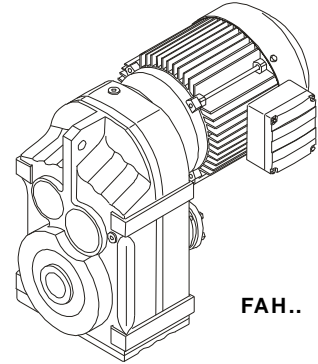

FAH..

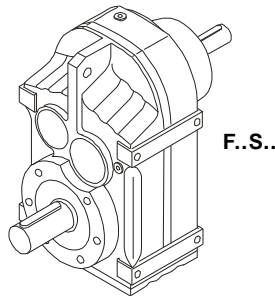

F..S..

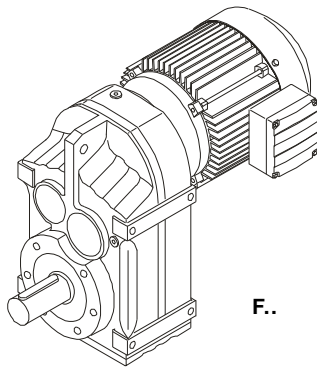

F..

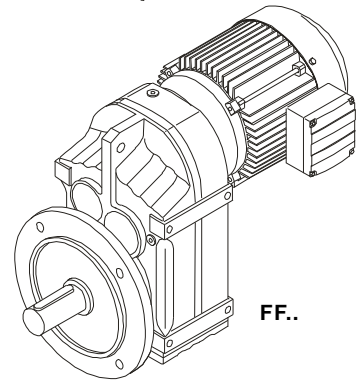

FF..

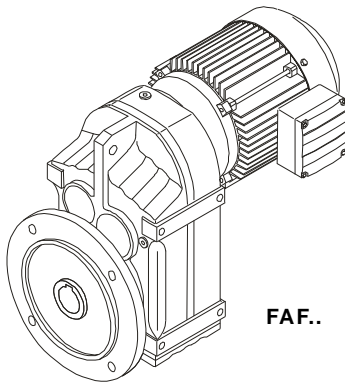

FAF..

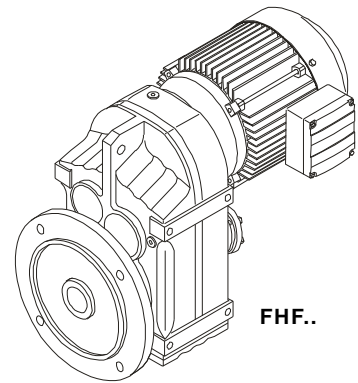

FHF..

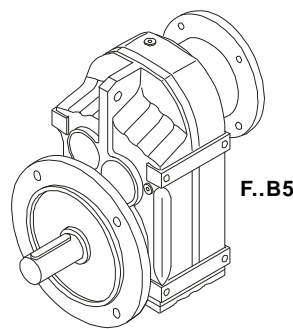

F..B5

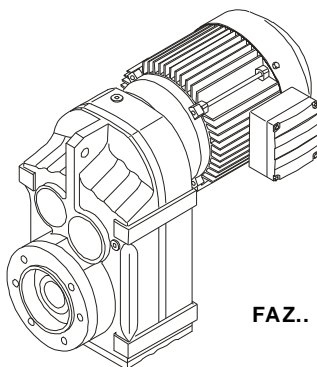

FAZ..

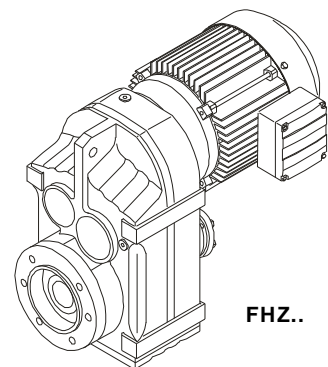

FHZ..



## 型号标记

## Designation

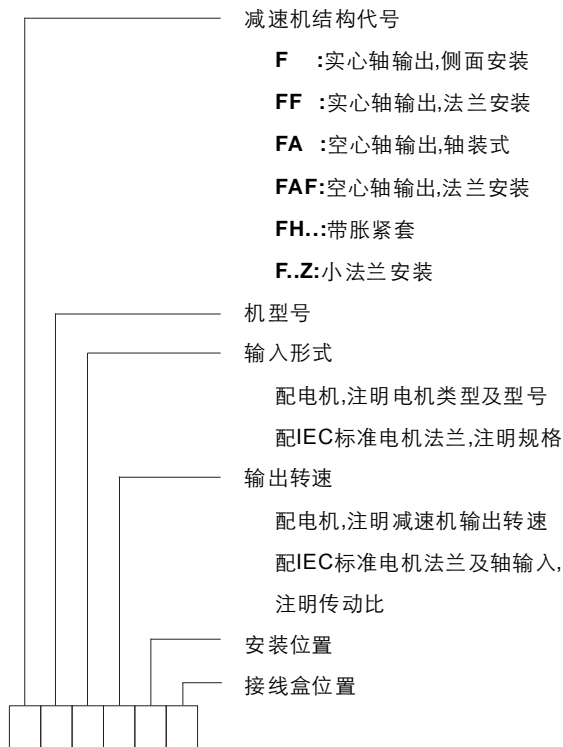

gear unit structure

- F** : solid shaft, rail-mounted
- FF** : solid shaft, flange-mounted
- FA** : hollow shaft with key, shaft-mounted
- FAF**: hollow shaft with key, flange-mounted
- FH..**: with shrink disk
- F..Z**: small flange mounting

gear unit size

input structure:

- connect with motor, indicate motor model
- connect with IEC flange, indicate frame

output speed

- connect with motor, indicate output speed
- connect with IEC flange or with input shaft, indicate ratio

mounting position

terminal box position

### 标记示例

- A FA77Y100L1-4NA39M1-270**  
输出空心孔定位,孔铰接安装,机型号77,电机规格Y100L1-4,输出转速39rpm,安装位置M1,电机接线盒位置270°
- B FA77BY100L1-4NA39M1-270**  
侧面螺纹孔安装,空心孔输出,机型号77,电机规格Y100L1-4,输出转速39rpm,安装位置M1,电机接线盒位置270°
- C FHF77YB100L1-4NA39M1-270 (dII BT4,IP54/F)**  
法兰安装,空心孔带胀紧套输出,机型号77,防爆电机YB100L1-4,防爆等级dII BT4,防护等级IP54,绝缘等级F,输出转速39rpm,安装位置M1,电机接线盒位置270°

### Sign Example

- A FA77Y100L1-4NA39M1-270**  
hollow shaft mounted with ream hole, gear unit size 47, motor frame Y100L1-4, output speed 39 rpm, mounting position M1, terminal box 270°
- B FA77BY100L1-4NA39M1-270**  
rail mounted with tapped holes, hollow shaft output, gear unit size 77, motor frame Y100L1-4, output speed 39rpm, mounting position M1, terminal box 270
- C FHF77YB100L1-4NA39M1-270 (dII BT4,IP54/F)**  
flange mounted, hollow shaft with shrink disc, gear unit size 77, exproof motor frame 100L1-4, protection IP54/F, output speed 39rpm, mounting position M1, terminal box 270

## 电机配置说明

## Configuration of Electric Motor

### Y系列普通三相异步电机

### Y series Three-phase Asynchronous Electric Motor

- 1 本系列减速机标准配置Y系列普通三相异步感应电机;
- 2 电机电压: 380V/50Hz;
- 3 电机防护等级IP54, 绝缘等级F, B级温升;
- 4 环境温度不超过40℃,不低于-15℃;
- 5 连续工作制S1;
- 6 海拔高度不超过1000m;

- 1 this series gear unit configure three-phase asynchronous electric motor;
- 2 voltage:380V/50Hz;
- 3 protection class:IP54,insulation class: F; temperature rising class: B;
- 4 ambient temperature:-15~40C ;
- 5 continue working duty:S1;
- 6 altitude less than 1000m;



## 电机配置说明

## Configuration of Electric Motor

### Y系列普通三相异步电机

- 7 冷却方式为C0141（风扇自冷）；
- 8 100及以下规格为"Y"接法，112M及以上规格为"Δ"接法；
- 9 优先选用 4, 6, 8极电机，2极电机不推荐使用；
- 10 电机技术参数见第433-438页

### YEJ系列三相异步制动电机

- 1 三相异步制动电机为普通电机的基础上附加制动器；
- 2 电机电压：380V/50Hz；
- 3 制动器电压：规格71~100: DC99V  
规格112~200: DC170V
- 4 配置单相AC220/50Hz整流器；
- 5 电机防护等级IP44，绝缘等级F, B级温升；
- 6 环境温度不超过40℃,不低于-15℃；
- 7 连续工作制S1；
- 8 海拔高度不超过1000m；
- 9 冷却方式为C0141（风扇自冷）；
- 10 100及以下规格为"Y"接法，112M及以上规格为"Δ"接法；
- 11 优先选用 4, 6, 8极电机，2极电机不推荐使用。
- 12 电机技术参数见第433-438页

### YVF系列三相异步变频电机

- 1 电机电压：380V；
- 2 基准频率：50Hz；
- 3 允许调频5~50Hz，恒转矩调速；
- 4 电机防护等级IP54，绝缘等级F, B级温升；
- 5 环境温度不超过40℃,不低于-15℃；
- 6 连续工作制S1；
- 7 海拔高度不超过1000m；
- 8 冷却方式为C416（独立风扇）；
- 9 接线方式按适配变频器要求；
- 10 优先选用 4极电机。

### 特殊电机

- 1 选用包括防爆电机，辊道电机，船用电机，多速电机等特殊电机，  
本公司提供IEC标准电机法兰接口，接口尺寸见243-244页；
- 2 异频率，异电压电机，请联系本公司技术部；
- 3 使用环境温度不在-15~40℃范围内，请联系本公司技术部；
- 4 更高的绝缘等级及防护等级，请联系本公司技术部。

### Y series Three-phase Asynchronous Electric Motor

- 7 self-cooling with fan:C0141；
- 8 within frame 100, follow connection Y, from frame 112,  
follow connection Δ；
- 9 first select 4,6,8 poles motor；
- 10 technical data on page 433-438.

### YEJ series Three-phase Asynchronous Brake Motor

- 1 base on Y series motor, add a brake.
- 2 voltage:380V/50Hz；
- 3 brake voltage: frame:71~100 DC99V  
frame:112~200 DC170V；
- 4 with single phase AC220V/50Hz rectifier；
- 5 protection class:IP54,insulation class: F, temperature rising  
class: B；
- 6 ambient temperature:-15~40℃；
- 7 continue working duty:S1；
- 8 altitude less than 1000m；
- 9 self-cooling with fan:C0141；
- 10 within frame 100, follow connection Y, from frame 112,  
follow connection Δ；
- 11 first select 4,6,8 poles motor；
- 12 technical data on page 433-438.

### YVF series Three-phase Variable-frequency Motor

- 1 voltage:380V；
- 2 rated frequency 50Hz；
- 3 available frequency:5~50Hz；
- 4 protection class:IP54,insulation class: F, temperature rising  
class:B；
- 5 ambient temperature:-15~40℃；
- 6 continue working duty:S1；
- 7 altitude less than 1000m；
- 8 cooling with independence fan:C416；
- 9 connection perform the requirement of inverter；
- 10 first select 4 poles motor；

### Customized Motor

- 1 others like explosion proof, roller motor, marine motor or  
multi-speed motor coupled by adaptor, the dimensions on  
page 243-244.
- 2 need different frequency and voltage, please contact us.
- 3 ambient temperature is not in -15~40℃, please contact us.
- 4 for higher insulation and protection class, please contact us.



安装位置

Mounting Position

F, FA, FAH, FAZ 减速机安装位置

F, FA, FAH, FAZ Gear Unit Mounting Position

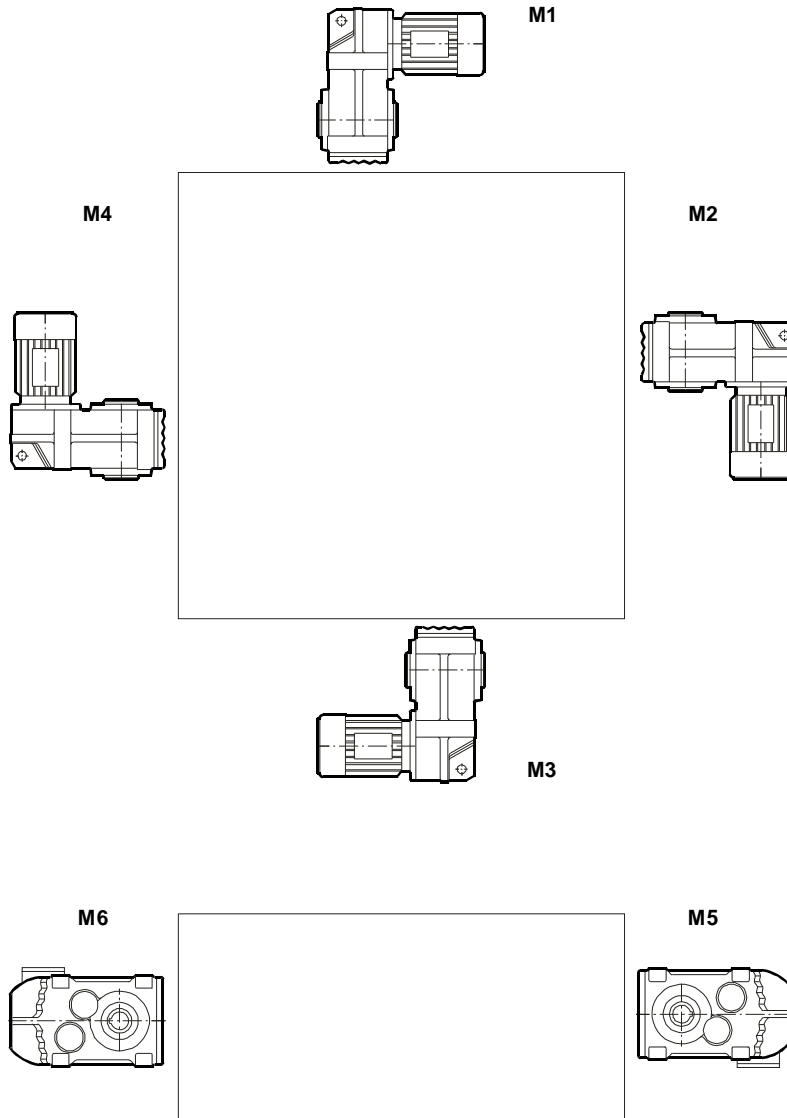

接线盒位置

Terminal Box Position

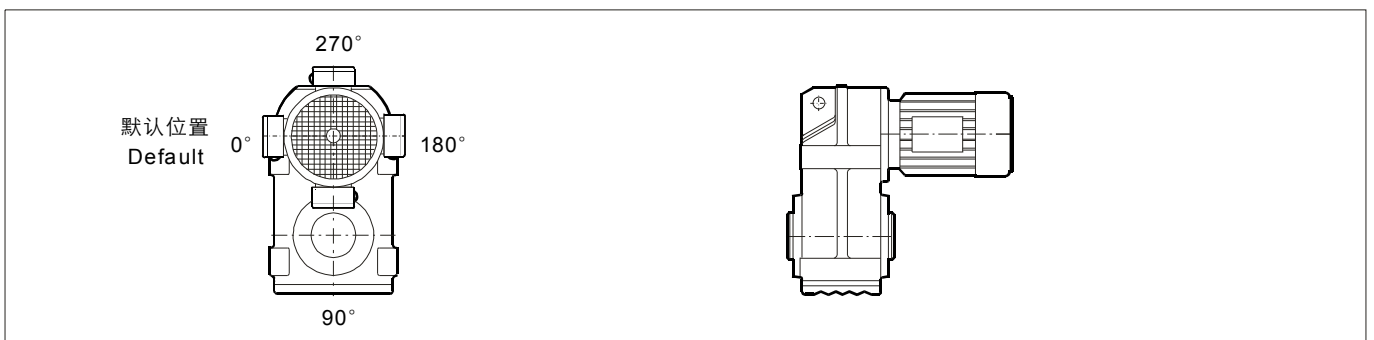



安装位置

Mounting Position

FF, FAF, FHF 减速机安装位置

FF, FAF, FHF Gear Unit Mounting Position

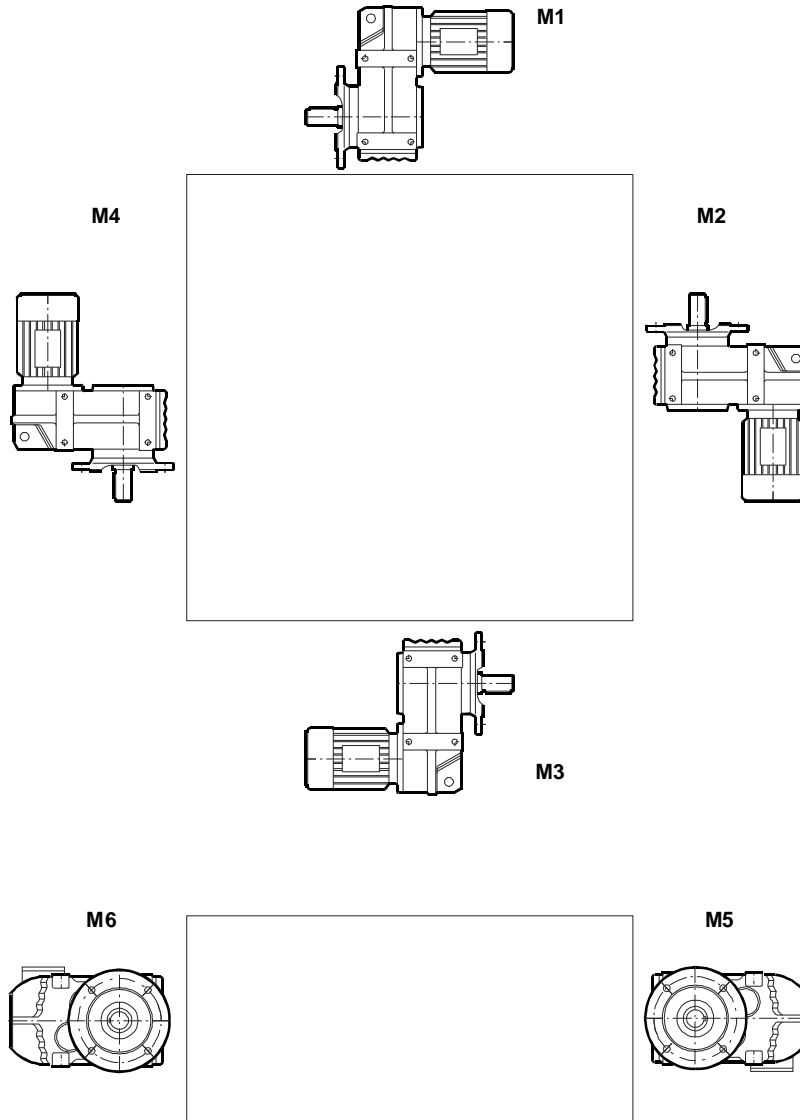

接线盒位置

Terminal Box Position

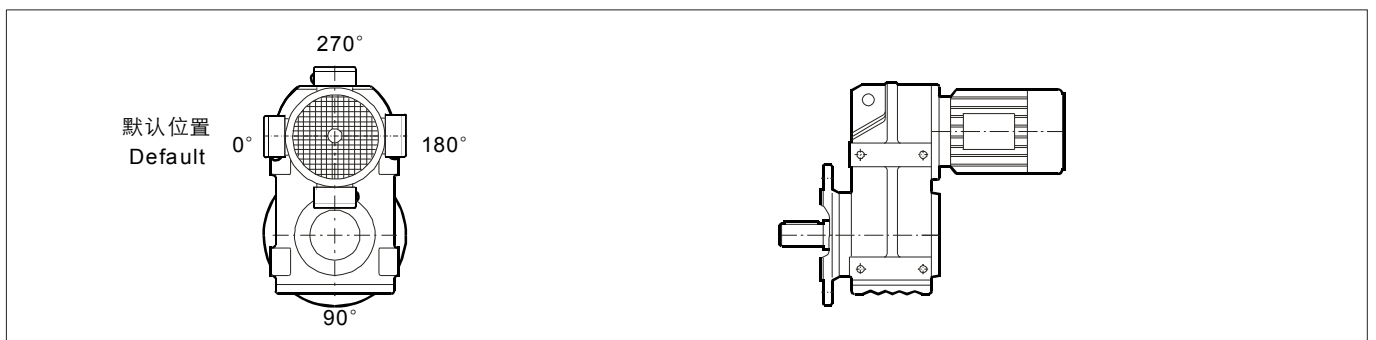



技术参数

Technical Data

符号意义

Key to Symbols

①  
↓

**$P_1 = 0.12 \text{ kW}$**

NA rpm	M <sub>2</sub> Nm	i	Fr <sub>2MAX</sub> [N]	f <sub>s</sub>	Type	Gear unit	Motor size	 Kg
0.06	13900	22323	86700	0.85				
0.07	11900	19048	90000	1.00	FA	127 R77	63M1-4	425
0.08	10400	16656	90000	1.15	FAF	127 R77	63M1-4	465
0.09	9180	14722	90000	1.30	F	127 R77	63M1-4	460
0.11	8000	12912	90000	1.50	FF	127 R77	63M1-4	510
0.12	7050	11656	90000	1.70				
0.14	6310	10191	90000	1.90				

↑  
②

↑  
③

↑  
④

↑  
⑤

↑  
⑥

↑  
⑦

↑  
⑧

↑  
⑨

↑  
⑩

- 1 电机功率
- 2 输出转速
- 3 输出转矩
- 4 减速比
- 5 输出轴中最大点载荷
- 6 使用系数
- 7 减速机类型
- 8 减速机规格
- 9 电机型号
- 10 大概重量

- 1 motor power
- 2 output speed
- 3 output torque
- 4 transmission ratio
- 5 maximum load on middle output shaft
- 6 service factor
- 7 gear unit type
- 8 gear unit size
- 9 motor frame
- 10 approximate weight



技术参数

Technical Data

P <sub>1</sub> = 0.12 kW								
N <sub>A</sub> rpm	M <sub>2</sub> Nm	i	Fr <sub>2</sub> MAX[N]	f <sub>s</sub>	Type	Gear unit	Motor size	 Kg
0.06	13900	22323	86700	0.85				
0.07	11900	19048	90000	1.00				
0.08	10400	16656	90000	1.15	FA	127 R77	63M1-4	425
0.09	9180	14722	90000	1.30	FAF	127 R77	63M1-4	465
0.11	8000	12912	90000	1.50	F	127 R77	63M1-4	460
0.12	7050	11656	90000	1.70	FF	127 R77	63M1-4	510
0.14	6310	10191	90000	1.90				
0.09	9210	14767	45500	0.85				
0.12	7080	11348	51400	1.10				
0.14	5750	10039	54600	1.35				
0.16	4680	8548	57000	1.65	FA	107 R77	63M1-4	275
0.18	4750	7674	56800	1.60	FAF	107 R77	63M1-4	295
0.20	4090	6767	58200	1.90	F	107 R77	63M1-4	290
0.23	3470	5954	59500	2.2	FF	107 R77	63M1-4	320
0.26	2990	5223	60400	2.6				
0.30	2850	4567	60700	2.7				
0.39	2130	3521	62000	3.6				
0.21	4150	6469	30400	1.05	FA	97 R57	63M1-4	185
0.25	3820	5615	31300	1.15	FAF	97 R57	63M1-4	205
0.28	3320	4961	32500	1.30	F	97 R57	63M1-4	190
0.32	2900	4333	33500	1.50	FF	97 R57	63M1-4	225
0.35	2690	3906	34000	1.60	FA	97 R57	63M1-4	185
0.41	2320	3352	34800	1.85	FAF	97 R57	63M1-4	205
0.47	1920	2907	35500	2.2	F	97 R57	63M1-4	190
0.54	1760	2553	35800	2.4	FF	97 R57	63M1-4	225
0.33	2770	4245	23800	1.10	FA	87 R57	63M1-4	120
0.37	2220	3721	25800	1.35	FAF	87 R57	63M1-4	130
					F	87 R57	63M1-4	125
					FF	87 R57	63M1-4	140
0.43	2250	3244	25700	1.35				
0.48	1990	2881	26500	1.50				
0.54	1780	2576	27100	1.70	FA	87 R57	63M1-4	115
0.63	1520	2199	27800	2.0	FAF	87 R57	63M1-4	130
0.72	1310	1930	28300	2.3	F	87 R57	63M1-4	125
0.81	1180	1709	28600	2.6	FF	87 R57	63M1-4	140
0.92	1030	1493	28900	2.9				
1.1	820	1300	29300	3.7				
1.2	745	1148	29500	4.0				
0.53	1820	2613	13000	0.80	FA	77 R37	63M1-4	65
0.60	1570	2284	15200	0.95	FAF	77 R37	63M1-4	72
0.68	1390	2029	16400	1.10	F	77 R37	63M1-4	69
					FF	77 R37	63M1-4	80





## 技术参数

## Technical Data

P <sub>1</sub> = 0.12 kW								
N <sub>A</sub> rpm	M <sub>2</sub> Nm	i	Fr <sub>2</sub> MAX[N]	f <sub>s</sub>	Type	Gear unit	Motor size	 Kg
0.80	1180	1728	17500	1.25				
0.89	1090	1544	17900	1.40				
1.0	960	1354	18500	1.55	FA	77 R37	63M1-4	65
1.2	850	1200	18800	1.75	FAF	77 R37	63M1-4	72
1.3	745	1053	19100	2.0	F	77 R37	63M1-4	69
1.5	635	910	19400	2.4	FF	77 R37	63M1-4	80
1.7	530	810	19600	2.8				
1.9	465	710	19800	3.2				
0.97	960	1429	7070	0.85				
1.1	870	1271	9850	0.95				
1.2	725	1102	11100	1.15				
1.4	640	970	11700	1.30	FA	67 R37	63M1-4	43
1.6	560	858	12100	1.45	FAF	67 R37	63M1-4	49
1.8	495	755	12400	1.65	F	67 R37	63M1-4	46
2.1	420	641	12700	1.95	FF	67 R37	63M1-4	52
2.4	390	572	12800	2.1				
2.7	330	509	13000	2.5				
3.2	290	437	13000	2.9				
1.6	615	851	9100	1.00				
1.9	525	738	9750	1.15	FA	57 R37	63M1-4	39
2.1	455	646	10200	1.30	FAF	57 R37	63M1-4	45
2.5	390	558	10600	1.55	F	57 R37	63M1-4	39
2.7	345	506	10900	1.75	FF	57 R37	63M1-4	46
3.1	300	452	11100	2.0				
3.2	310	426	11100	1.95	FA	57 R37	63M1-4	38
3.6	275	382	11300	2.2	FAF	57 R37	63M1-4	44
4.2	235	330	11500	2.6	F	57 R37	63M1-4	39
4.6	210	298	11500	2.9	FF	57 R37	63M1-4	45
5.3	185	262	11500	3.2				
2.5	385	543	6100	1.05	FA	47 R17	63M1-4	24
2.9	335	475	6740	1.20	FAF	47 R17	63M1-4	27
3.3	290	419	7150	1.40	F	47 R17	63M1-4	25
					FF	47 R17	63M1-4	28
2.6	380	524	6190	1.05				
2.8	355	489	6530	1.15	FA	47 R17	63M1-4	23
3.2	305	427	7020	1.30	FAF	47 R17	63M1-4	26
3.6	270	381	7310	1.50	F	47 R17	63M1-4	24
4.1	235	334	7550	1.70	FF	47 R17	63M1-4	27
4.7	205	295	7740	1.95				
5.5	172	253	7910	2.3				
4.3	220	322	3990	0.90	FA	37 R17	63M1-4	19
5.0	192	278	4410	1.05	FAF	37 R17	63M1-4	20
5.7	162	242	4750	1.25	F	37 R17	63M1-4	19
6.2	156	221	4820	1.30	FF	37 R17	63M1-4	21



## 技术参数

## Technical Data

P <sub>1</sub> = 0.12 kW								
NA rpm	M <sub>2</sub> Nm	i	Fr <sub>2</sub> MAX[N]	f <sub>s</sub>	Type	Gear unit	Motor size	 Kg
4.2	235	326	3710	0.85				
4.9	205	285	4250	1.00	FA	37 R17	63M1-4	19
5.5	177	250	4590	1.15	FAF	37 R17	63M1-4	20
6.3	156	219	4820	1.30	F	37 R17	63M1-4	19
7.4	132	186	5040	1.50	FF	37 R17	63M1-4	21
8.3	118	167	5140	1.70				
6.2	155	221	4500	0.85	FA	27 R17	63M1-4	13
8.0	119	172	4500	1.10	FAF	27 R17	63M1-4	14
9.1	104	153	4500	1.25	F	27 R17	63M1-4	13
11	87	130	4500	1.50	FF	27 R17	63M1-4	14
6.5	150	211	4500	0.85				
7.4	131	186	4500	1.00	FA	27 R17	63M1-4	13
9.7	102	142	4500	1.25	FAF	27 R17	63M1-4	13
11	88	124	4500	1.45	F	27 R17	63M1-4	13
13	77	109	4500	1.70	FF	27 R17	63M1-4	14
14	67	96	4500	1.95				
3.9	290	228.99	13000	2.8	FA	67	63M2-6	32
4.6	250	195.39	13000	3.3	FAF	67	63M2-6	38
5.3	220	170.85	13000	3.8	F	67	63M2-6	35
5.5	205	162.31	13000	4.0	FF	67	63M2-6	41
6.3	181	142.40	13000	4.5				
4.5	255	199.70	11400	2.4	FA	57	63M2-6	28
4.9	235	183.60	11500	2.6	FAF	57	63M2-6	34
5.7	200	157.09	11500	3.0	F	57	63M2-6	28
6.6	173	136.16	11500	3.5	FF	57	63M2-6	35
7.1	162	127.27	11500	3.7				
6.9	166	199.70	11500	3.6	FA	57	63M1-4	28
7.5	153	183.60	11500	3.9	FAF	57	63M1-4	34
8.8	130	157.09	11500	4.6	F	57	63M1-4	28
10	113	136.16	11500	5.3	FF	57	63M1-4	35
4.7	245	190.76	7510	1.65				
5.1	225	175.38	7640	1.80				
6.0	191	150.06	7820	2.1	FA	47	63M2-6	21
6.9	166	130.07	7940	2.4	FAF	47	63M2-6	24
7.4	155	121.57	7990	2.6	F	47	63M2-6	22
8.6	134	105.09	8070	3.0	FF	47	63M2-6	25
10	114	89.29	8130	3.5				
11	102	79.72	8160	3.9				
7.2	158	190.76	7970	2.5	FA	47	63M1-4	21
7.9	146	175.38	8020	2.8	FAF	47	63M1-4	24
9.2	125	150.06	8100	3.2	F	47	63M1-4	22
11	108	130.07	8150	3.7	FF	47	63M1-4	25



## 技术参数

## Technical Data

**P<sub>1</sub> = 0.12 kW**

<b>N<sub>A</sub></b> rpm	<b>M<sub>2</sub></b> Nm	<b>i</b>	<b>Fr<sub>2MAX</sub>[N]</b>	<b>f<sub>s</sub></b>	<b>Type</b>	<b>Gear unit</b>	<b>Motor size</b>	 Kg
7.0	164	128.51	4740	1.20	FA	37	63M2-6	16
7.6	150	117.88	4880	1.35	FAF	37	63M2-6	18
9.0	128	100.36	5070	1.55	F	37	63M2-6	17
10	110	86.53	5190	1.80	FF	37	63M2-6	18
11	103	80.65	5240	1.95				
11	107	128.51	5220	1.85	FA	37	63M1-4	16
12	98	117.88	5270	2.0	FAF	37	63M1-4	18
14	83	100.36	5340	2.4	F	37	63M1-4	17
16	72	86.53	5400	2.8	FF	37	63M1-4	18
17	67	80.65	5410	3.0				

**P<sub>1</sub> = 0.18 kW**

0.10	13700	12912	87200	0.90				
0.11	12200	11656	90000	1.00	FA	127 R77	63M2-4	425
0.13	10800	10191	90000	1.10	FAF	127 R77	63M2-4	465
0.15	8950	8831	90000	1.35	F	127 R77	63M2-4	460
0.17	7740	7643	90000	1.55	FF	127 R77	63M2-4	510
0.20	7130	6715	90000	1.70				
0.15	8450	8548	47700	0.90				
0.17	8130	7674	48600	0.95	FA	107 R77	63M2-4	275
0.20	7070	6767	51400	1.10	FAF	107 R77	63M2-4	295
0.22	6090	5954	53800	1.25	F	107 R77	63M2-4	290
0.25	5290	5223	55700	1.45	FF	107 R77	63M2-4	320
0.29	4850	4567	56600	1.60				
0.37	3680	3521	59100	2.1				
0.43	3260	3037	59900	2.4	FA	107 R77	63M2-4	275
0.48	2960	2756	60500	2.6	FAF	107 R77	63M2-4	295
0.56	2540	2369	61200	3.0	F	107 R77	63M2-4	290
0.64	2220	2068	61800	3.5	FF	107 R77	63M2-4	315
0.30	4810	4333	22800	0.90				
0.34	4430	3906	29500	0.95				
0.39	3810	3352	31300	1.15				
0.45	3210	2907	32800	1.35	FA	97 R57	63M2-4	185
0.52	2900	2553	33600	1.50	FAF	97 R57	63M2-4	205
0.59	2550	2245	34300	1.70	F	97 R57	63M2-4	190
0.67	2210	1970	35000	1.95	FF	97 R57	63M2-4	225
0.77	1960	1722	35500	2.2				
0.86	1740	1527	35900	2.5				
0.99	1430	1327	36400	3.0				
1.1	1330	1171	36500	3.2				



## 技术参数

## Technical Data

P <sub>1</sub> = 0.18 kW								
N <sub>A</sub> rpm	M <sub>2</sub> Nm	i	Fr <sub>2</sub> MAX[N]	f <sub>s</sub>	Type	Gear unit	Motor size	 Kg
0.51	2930	2576	22300	1.00				
0.60	2490	2199	24800	1.20				
0.68	2170	1930	25900	1.40				
0.77	1940	1709	26600	1.55	FA	87 R57	63M2-4	115
0.88	1700	1493	27300	1.75	FAF	87 R57	63M2-4	130
1.0	1400	1300	28100	2.1	F	87 R57	63M2-4	125
1.2	1260	1148	28400	2.4	FF	87 R57	63M2-4	140
1.3	1090	1010	28800	2.8				
1.5	970	887	29000	3.1				
1.7	840	780	29300	3.6				
0.86	1780	1544	13500	0.85				
0.98	1560	1354	15300	0.95				
1.1	1380	1200	16500	1.10	FA	77 R37	63M2-4	65
1.2	1210	1053	17400	1.25	FAF	77 R37	63M2-4	72
1.4	1040	910	18200	1.45	F	77 R37	63M2-4	69
1.6	890	810	18700	1.70	FF	77 R37	63M2-4	80
1.9	780	710	19000	1.90				
2.1	695	615	19300	2.2				
1.5	940	858	8660	0.85				
1.8	830	755	10200	1.00				
2.1	705	641	11200	1.15	FA	67 R37	63M2-4	43
2.3	645	572	11600	1.25	FAF	67 R37	63M2-4	49
2.6	560	509	12100	1.45	F	67 R37	63M2-4	46
3.0	480	437	12500	1.70	FF	67 R37	63M2-4	52
3.4	435	384	12700	1.90				
2.6	580	500	12000	1.40				
2.9	530	454	12300	1.55				
3.4	455	392	12600	1.80	FA	67 R37	63M2-4	42
4.0	380	333	12900	2.2	FAF	67 R37	63M2-4	48
4.4	335	297	13000	2.4	F	67 R37	63M2-4	45
5.1	295	261	13000	2.8	FF	67 R37	63M2-4	51
5.5	265	238	13000	3.1				
6.6	220	200	13000	3.7				
2.4	640	558	7570	0.95				
2.6	570	506	9420	1.05	FA	57 R37	63M2-4	39
2.9	500	452	9930	1.20	FAF	57 R37	63M2-4	45
3.4	425	386	10400	1.40	F	57 R37	63M2-4	39
3.9	370	338	10700	1.60	FF	57 R37	63M2-4	46



## 技术参数

## Technical Data

P <sub>1</sub> = 0.18 kW								
NA rpm	M <sub>2</sub> Nm	i	Fr <sub>2</sub> MAX[N]	f <sub>s</sub>	Type	Gear unit	Motor size	 Kg
3.1	500	426	9910	1.20				
3.5	445	382	10300	1.35				
4.0	380	330	10700	1.55	FA	57 R37	63M2-4	38
4.4	345	298	10900	1.75	FAF	57 R37	63M2-4	44
5.0	305	262	11100	2.0	F	57 R37	63M2-4	39
5.8	255	226	11400	2.3	FF	57 R37	63M2-4	45
6.6	225	200	11500	2.7				
3.6	410	370	5210	0.95	FA	47 R17	63M2-4	24
4.1	375	324	6250	1.05	FAF	47 R17	63M2-4	27
4.6	325	288	6810	1.20	F	47 R17	63M2-4	25
5.3	280	249	7250	1.45	FF	47 R17	63M2-4	28
7.1	215	186	4060	0.95	FA	37 R17	63M2-4	19
7.9	194	167	4380	1.05	FAF	37 R17	63M2-4	20
9.1	171	145	4660	1.15	F	37 R17	63M2-4	19
10	151	129	4870	1.30	FF	37 R17	63M2-4	21
9.3	166	142	4500	0.80	FA	27 R17	63M2-4	13
11	144	124	4500	0.90	FAF	27 R17	63M2-4	13
12	126	109	4500	1.05	F	27 R17	63M2-4	13
14	110	96	4500	1.20	FF	27 R17	63M2-4	14
3.1	555	281.71	19600	2.7	FA	77	71M1-6	57
3.3	520	262.93	19700	2.9	FAF	77	71M1-6	63
3.9	445	225.79	19800	3.4	F	77	71M1-6	60
					FF	77	71M1-6	71
3.8	450	228.99	12600	1.80	FA	67	71M1-6	33
4.5	385	195.39	12900	2.1	FAF	67	71M1-6	39
5.1	340	170.85	13000	2.4	F	67	71M1-6	36
					FF	67	71M1-6	42
5.8	300	228.99	13000	2.8	FA	67	63M2-4	32
6.8	255	195.39	13000	3.2	FAF	67	63M2-4	38
7.7	225	170.85	13000	3.7	F	67	63M2-4	35
					FF	67	63M2-4	41
4.4	395	199.70	10600	1.50				
4.7	365	183.60	10800	1.65	FA	57	71M1-6	29
5.5	310	157.09	11100	1.95	FAF	57	71M1-6	34
6.4	270	136.16	11300	2.2	F	57	71M1-6	29
6.8	250	127.27	11400	2.4	FF	57	71M1-6	36
7.9	215	110.01	11500	2.8				
6.6	260	199.70	11300	2.3	FA	57	63M2-4	28
7.2	240	183.60	11500	2.5	FAF	57	63M2-4	34
8.4	205	157.09	11500	2.9	F	57	63M2-4	28
9.7	177	136.16	11500	3.4	FF	57	63M2-4	35
10	166	127.27	11500	3.6				



## 技术参数

## Technical Data

**P<sub>1</sub> = 0.18 kW**

<b>N<sub>A</sub></b> rpm	<b>M<sub>2</sub></b> Nm	<b>i</b>	<b>Fr<sub>2</sub>MAX[N]</b>	<b>f<sub>s</sub></b>	<b>Type</b>	<b>Gear unit</b>	<b>Motor size</b>	 Kg
4.6	375	190.76	6240	1.05				
5.0	345	175.38	6600	1.15	FA	47	71M1-6	22
5.8	295	150.06	7090	1.35	FAF	47	71M1-6	24
6.7	255	130.07	7410	1.55	F	47	71M1-6	22
7.2	240	121.57	7530	1.65	FF	47	71M1-6	26
<hr/>								
6.9	250	190.76	7470	1.60	FA	47	63M2-4	21
7.5	230	175.38	7610	1.75	FAF	47	63M2-4	24
8.8	195	150.06	7800	2.1	F	47	63M2-4	22
10	169	130.07	7920	2.4	FF	47	63M2-4	25
11	158	121.57	7970	2.5				
<hr/>								
7.4	235	117.88	3750	0.85	FA	37	71M1-6	17
8.7	198	100.36	4320	1.00	FAF	37	71M1-6	18
10	171	86.53	4660	1.15	F	37	71M1-6	17
11	159	80.65	4790	1.25	FF	37	71M1-6	19
12	139	70.50	4970	1.45				
<hr/>								
10	167	128.51	4700	1.20				
11	154	117.88	4850	1.30				
13	131	100.36	5050	1.55	FA	37	63M2-4	16
15	113	86.53	5180	1.75	FAF	37	63M2-4	18
16	105	80.65	5230	1.90	F	37	63M2-4	17
19	92	70.50	5300	2.2	FF	37	63M2-4	18
20	86	66.09	5330	2.3				
23	76	58.32	5380	2.6				
<hr/>								
335	5.1	8.13	2190	24				
394	4.4	6.91	2080	26	FA	27	63MM1-2	9.6
441	3.9	6.17	2010	28	FAF	27	63MM1-2	10
516	3.3	5.27	1910	30	F	27	63MM1-2	10
551	3.1	4.93	1870	31	FF	27	63MM1-2	11
655	2.6	4.16	1770	34				

**P<sub>1</sub> = 0.25 kW**

0.15	13300	8831	87900	0.90				
0.17	11500	7643	90000	1.05	FA	127 R77	71M1-4	425
0.19	10500	6715	90000	1.15	FAF	127 R77	71M1-4	465
0.22	9240	5925	90000	1.30	F	127 R77	71M1-4	465
0.25	7950	5153	90000	1.50	FF	127 R77	71M1-4	510
0.29	6890	4533	90000	1.75				
<hr/>								
0.22	9050	5954	46000	0.85	FA	107 R77	71M1-4	275
0.25	7890	5223	49300	0.95	FAF	107 R77	71M1-4	295
0.28	7120	4567	51300	1.10	F	107 R77	71M1-4	290
0.37	5430	3521	55300	1.40	FF	107 R77	71M1-4	320



## 技术参数

## Technical Data

P <sub>1</sub> = 0.25 kW								
N <sub>A</sub> rpm	M <sub>2</sub> Nm	i	Fr <sub>2</sub> MAX[N]	f <sub>s</sub>	Type	Gear unit	Motor size	 Kg
0.43	4790	3037	56800	1.60				
0.47	4340	2756	57700	1.75	FA	107 R77	71M1-4	275
0.55	3730	2369	59000	2.1	FAF	107 R77	71M1-4	295
0.63	3260	2068	59900	2.4	F	107 R77	71M1-4	290
0.81	2490	1597	61300	3.1	FF	107 R77	71M1-4	320
0.93	2160	1401	61900	3.6				
<hr/>								
0.45	4680	2907	27500	0.90				
0.51	4180	2553	30300	1.05				
0.58	3680	2245	31600	1.15	FA	97 R57	71M1-4	185
0.66	3200	1970	32800	1.35	FAF	97 R57	71M1-4	205
0.75	2820	1722	33700	1.50	F	97 R57	71M1-4	190
0.85	2500	1527	34400	1.70	FF	97 R57	71M1-4	225
0.98	2100	1327	35200	2.1				
1.1	1920	1171	35500	2.2				
1.3	1680	1022	36000	2.6				
<hr/>								
0.67	3140	1930	13500	0.95				
0.76	2800	1709	23700	1.05				
0.87	2450	1493	25000	1.25	FA	87 R57	71M1-4	120
1.0	2050	1300	26300	1.45	FAF	87 R57	71M1-4	130
1.1	1830	1148	26900	1.65	F	87 R57	71M1-4	125
1.3	1600	1010	27600	1.90	FF	87 R57	71M1-4	140
1.5	1420	887	28000	2.1				
1.7	1230	780	28500	2.4				
1.9	1050	674	28900	2.9				
<hr/>								
1.2	1740	1053	13900	0.85				
1.4	1500	910	15700	1.00				
1.6	1300	810	16900	1.15	FA	77 R37	71M1-4	66
1.8	1140	710	17700	1.30	FAF	77 R37	71M1-4	72
2.1	1000	615	18300	1.50	F	77 R37	71M1-4	70
2.4	880	538	18700	1.70	FF	77 R37	71M1-4	80
2.7	780	480	19000	1.95				
3.1	660	413	19400	2.3				
<hr/>								
2.3	930	572	9150	0.90	FA	67 R37	71M1-4	44
2.6	810	509	10400	1.00	FAF	67 R37	71M1-4	50
3.0	700	437	11200	1.15	F	67 R37	71M1-4	46
					FF	67 R37	71M1-4	53
<hr/>								
2.6	830	500	10200	1.00				
2.9	760	454	10800	1.10	FA	67 R37	71M1-4	42
3.3	655	392	11600	1.25	FAF	67 R37	71M1-4	49
3.9	550	333	12200	1.50	F	67 R37	71M1-4	45
4.4	490	297	12500	1.70	FF	67 R37	71M1-4	51
5.0	430	261	12700	1.90				
5.5	385	238	12900	2.1				



## 技术参数

## Technical Data

P <sub>1</sub> = 0.25 kW								
N <sub>A</sub> rpm	M <sub>2</sub> Nm	i	Fr <sub>2</sub> MAX[N]	f <sub>s</sub>	Type	Gear unit	Motor size	 Kg
3.4	620	386	8830	0.95	FA	57 R37	71M1-4	40
3.9	540	338	9640	1.10	FAF	57 R37	71M1-4	45
5.1	410	255	10500	1.45	F	57 R37	71M1-4	40
					FF	57 R37	71M1-4	46
3.4	640	382	7390	0.95				
3.9	550	330	9570	1.10	FA	57 R37	71M1-4	39
4.4	495	298	9950	1.20	FAF	57 R37	71M1-4	45
5.0	435	262	10300	1.35	F	57 R37	71M1-4	39
5.8	370	226	10700	1.60	FF	57 R37	71M1-4	46
6.5	325	200	11000	1.85				
7.7	275	170	11300	2.2				
5.2	405	249	5880	1.00	FA	47 R17	71M1-4	25
6.0	360	218	6470	1.10	FAF	47 R17	71M1-4	27
6.7	315	193	6920	1.25	F	47 R17	71M1-4	25
7.5	285	175	7180	1.40	FF	47 R17	71M1-4	28
5.1	415	253	4980	0.95				
6.0	365	217	6380	1.10	FA	47 R17	71M1-4	24
6.9	320	190	6900	1.25	FAF	47 R17	71M1-4	26
7.3	295	178	7090	1.35	F	47 R17	71M1-4	25
8.7	250	149	7480	1.60	FF	47 R17	71M1-4	28
9.9	215	131	7670	1.85				
8.9	245	145	3420	0.80	FA	37 R17	71M1-4	20
10	215	129	4040	0.90	FAF	37 R17	71M1-4	21
11	198	118	4320	1.00	F	37 R17	71M1-4	20
13	164	98	4740	1.20	FF	37 R17	71M1-4	22
15	144	87	4940	1.40				
3.1	765	281.71	19100	1.95	FA	77	71M2-6	57
3.4	715	262.93	19200	2.1	FAF	77	71M2-6	64
3.9	615	225.79	19500	2.5	F	77	71M2-6	61
4.4	540	198.31	19600	2.8	FF	77	71M2-6	72
4.7	510	188.40	19700	2.9				
3.8	620	228.99	11800	1.30	FA	67	71M2-6	34
4.5	530	195.39	12300	1.55	FAF	67	71M2-6	41
5.2	465	170.85	12600	1.75	F	67	71M2-6	37
5.4	440	162.31	12700	1.85	FF	67	71M2-6	43
6.2	385	142.40	12900	2.1				
5.7	420	228.99	12700	1.95	FA	67	71M1-4	33
6.7	360	195.39	13000	2.3	FAF	67	71M1-4	39
7.6	315	170.85	13000	2.6	F	67	71M1-4	36
8.0	300	162.31	13000	2.8	FF	67	71M1-4	42
9.1	260	142.40	13000	3.1				





## 技术参数

## Technical Data

P <sub>1</sub> = 0.25 kW								
N <sub>A</sub> rpm	M <sub>2</sub> Nm	i	Fr <sub>2</sub> MAX[N]	f <sub>s</sub>	Type	Gear unit	Motor size	 Kg
4.4	540	199.70	9630	1.10				
4.8	500	183.60	9940	1.20	FA	57	71M2-6	30
5.6	425	157.09	10400	1.40	FAF	57	71M2-6	36
6.5	370	136.16	10800	1.60	F	57	71M2-6	31
6.9	345	127.27	10900	1.75	FF	57	71M2-6	37
8.0	300	110.01	11100	2.0				
6.5	365	199.70	10800	1.65				
7.1	335	183.60	10900	1.80	FA	57	71M1-4	29
8.3	290	157.09	11200	2.1	FAF	57	71M1-4	34
9.6	250	136.16	11400	2.4	F	57	71M1-4	29
10	235	127.27	11500	2.6	FF	57	71M1-4	36
12	200	110.01	11500	3.0				
5.9	405	150.06	5750	1.00	FA	47	71M2-6	22
6.8	355	130.07	6530	1.15	FAF	47	71M2-6	25
7.2	330	121.57	6770	1.20	F	47	71M2-6	23
8.4	285	105.09	7190	1.40	FF	47	71M2-6	26
6.8	350	190.76	6550	1.15				
7.4	320	175.38	6850	1.25	FA	47	71M1-4	22
8.7	275	150.06	7270	1.45	FAF	47	71M1-4	24
10	240	130.07	7540	1.65	F	47	71M1-4	22
11	225	121.57	7640	1.80	FF	47	71M1-4	26
12	193	105.09	7810	2.1				
15	164	89.29	7950	2.4				
10	235	128.51	3690	0.85				
11	215	117.88	4040	0.90				
13	184	100.36	4500	1.10				
15	159	86.53	4790	1.25				
16	148	80.65	4900	1.35				
18	130	70.50	5060	1.55				
20	121	66.09	5120	1.65	FA	37	71M1-4	17
22	107	58.32	5210	1.85	FAF	37	71M1-4	18
24	100	54.54	5260	2.0	F	37	71M1-4	17
25	95	51.70	5280	2.1	FF	37	71M1-4	19
28	86	47.02	5330	2.3				
30	81	43.83	5360	2.5				
34	70	38.31	5400	2.8				
36	66	35.91	5420	3.0				
41	58	31.69	5450	3.4				



## 技术参数

## Technical Data

P <sub>1</sub> = 0.37 kW								
N <sub>A</sub> rpm	M <sub>2</sub> Nm	i	Fr <sub>2</sub> MAX[N]	f <sub>s</sub>	Type	Gear unit	Motor size	 Kg
0.21	15000	6715	84600	0.80				
0.23	13200	5925	88100	0.90				
0.27	11400	5153	90000	1.05	FA	127 R77	71M2-4	425
0.30	9930	4533	90000	1.20	FAF	127 R77	71M2-4	465
0.35	8690	3926	90000	1.40	F	127 R77	71M2-4	465
0.40	7570	3454	90000	1.60	FF	127 R77	71M2-4	510
0.46	6610	3031	90000	1.80				
0.45	6850	3037	52000	1.10	FA	107 R77	71M2-4	275
0.50	6220	2756	53500	1.25	FAF	107 R77	71M2-4	295
0.58	5350	2369	55500	1.45	F	107 R77	71M2-4	290
0.67	4670	2068	57000	1.65	FF	107 R77	71M2-4	320
0.86	3580	1597	59300	2.2				
0.70	4540	1970	29200	0.95				
0.80	4000	1722	30800	1.10	FA	97 R57	71M2-4	185
0.90	3550	1527	32000	1.20	FAF	97 R57	71M2-4	205
1.0	3000	1327	33300	1.45	F	97 R57	71M2-4	190
1.2	2720	1171	33900	1.60	FF	97 R57	71M2-4	225
1.4	2370	1022	34700	1.80				
1.5	2000	898	35400	2.1				
1.1	2940	1300	22000	1.00				
1.2	2620	1148	24400	1.15				
1.4	2280	1010	25600	1.30	FA	87 R57	71M2-4	120
1.6	2020	887	26400	1.50	FAF	87 R57	71M2-4	130
1.8	1760	780	27100	1.70	F	87 R57	71M2-4	125
2.0	1500	674	27800	2.0	FF	87 R57	71M2-4	140
2.3	1380	609	28100	2.2				
2.7	1160	515	28600	2.6				
3.1	1020	452	28900	2.9				
1.7	1850	810	11300	0.80				
1.9	1620	710	14900	0.95				
2.2	1420	615	16200	1.05	FA	77 R37	71M2-4	67
2.6	1240	538	17200	1.20	FAF	77 R37	71M2-4	73
2.9	1110	480	17900	1.35	F	77 R37	71M2-4	71
3.4	940	413	18500	1.60	FF	77 R37	71M2-4	81
3.8	840	367	18900	1.80				
4.3	750	323	19100	2.0				
3.6	890	384	9670	0.95	FA	67 R37	71M2-4	45
4.1	785	338	10600	1.05	FAF	67 R37	71M2-4	51
4.5	705	305	11200	1.15	F	67 R37	71M2-4	47
5.4	590	257	11900	1.40	FF	67 R37	71M2-4	53
6.0	525	231	12300	1.55				
5.4	585	255	9330	1.05	FA	57 R37	71M2-4	41
6.9	455	201	10200	1.30	FAF	57 R37	71M2-4	46
7.6	415	181	10500	1.45	F	57 R37	71M2-4	41
					FF	57 R37	71M2-4	47



## 技术参数

## Technical Data

**P<sub>1</sub> = 0.37 kW**

<b>N<sub>A</sub></b> rpm	<b>M<sub>2</sub></b> Nm	<b>i</b>	<b>Fr<sub>2</sub>MAX[N]</b>	<b>f<sub>s</sub></b>	<b>Type</b>	<b>Gear unit</b>	<b>Motor size</b>	 Kg
5.3	620	262	9070	0.95				
6.1	525	226	9740	1.15	FA	57 R37	71M2-4	40
6.9	465	200	10200	1.30	FAF	57 R37	71M2-4	46
8.1	395	170	10600	1.50	F	57 R37	71M2-4	40
9.1	350	152	10900	1.70	FF	57 R37	71M2-4	47
10	310	134	11100	1.95				
7.9	405	175	5860	1.00	FA	47 R17	71M2-4	25
9.4	340	147	6660	1.15	FAF	47 R17	71M2-4	28
11	300	130	7050	1.35	F	47 R17	71M2-4	26
					FF	47 R17	71M2-4	29
2.5	1410	270.68	28100	2.1	FA	87	90S-8	105
2.7	1330	255.37	28200	2.3	FAF	87	90S-8	120
3.0	1190	228.93	28600	2.5	F	87	90S-8	110
3.5	1020	197.20	28900	2.9	FF	87	90S-8	125
3.3	1060	270.68	28800	2.8	FA	87	80M1-6	98
3.5	1000	255.37	29000	3.0	FAF	87	80M1-6	110
3.9	900	228.93	29200	3.3	F	87	80M1-6	105
					FF	87	80M1-6	120
4.0	890	225.79	18700	1.70	FA	77	80M1-6	59
4.5	780	198.31	19100	1.95	FAF	77	80M1-6	66
4.8	740	188.40	19200	2.0	F	77	80M1-6	63
5.4	655	166.47	19400	2.3	FF	77	80M1-6	74
6.3	560	142.27	19600	2.7				
4.9	720	281.71	19200	2.1	FA	77	71M2-4	57
5.2	675	262.93	19300	2.2	FAF	77	71M2-4	64
6.1	580	225.79	19500	2.6	F	77	71M2-4	61
7.0	510	198.31	19700	3.0	FF	77	71M2-4	72
4.6	765	195.39	10800	1.05	FA	67	80M1-6	36
5.3	670	170.85	11500	1.20	FAF	67	80M1-6	43
5.5	635	162.31	11700	1.30	F	67	80M1-6	39
6.3	560	142.40	12100	1.45	FF	67	80M1-6	45
7.5	475	120.79	12500	1.75				
6.0	585	228.99	12000	1.40				
7.1	500	195.39	12400	1.65	FA	67	71M2-4	34
8.1	435	170.85	12700	1.85	FAF	67	71M2-4	41
8.5	415	162.31	12800	1.95	F	67	71M2-4	37
9.7	365	142.40	12900	2.3	FF	67	71M2-4	43
11	310	120.79	13000	2.7				



## 技术参数

## Technical Data

P <sub>1</sub> = 0.37 kW								
N <sub>A</sub> rpm	M <sub>2</sub> Nm	i	Fr <sub>2</sub> MAX[N]	f <sub>s</sub>	Type	Gear unit	Motor size	 Kg
5.7	615	157.09	9070	0.95	FA	57	80M1-6	32
6.6	535	136.16	9680	1.10	FAF	57	80M1-6	38
7.1	500	127.27	9930	1.20	F	57	80M1-6	33
8.2	430	110.01	10400	1.40	FF	57	80M1-6	39
6.9	510	199.70	9850	1.15				
7.5	470	183.60	10100	1.30				
8.8	400	157.09	10600	1.50	FA	57	71M2-4	30
10	350	136.16	10900	1.70	FAF	57	71M2-4	36
11	325	127.27	11000	1.85	F	57	71M2-4	31
13	280	110.01	11200	2.1	FF	57	71M2-4	37
15	240	93.47	11500	2.5				
17	215	83.46	11500	2.8				
9.2	385	150.06	6140	1.05				
11	335	130.07	6740	1.20	FA	47	71M2-4	22
13	270	105.09	7320	1.50	FAF	47	71M2-4	25
15	230	89.29	7600	1.75	F	47	71M2-4	23
17	205	79.72	7750	1.95	FF	47	71M2-4	26
20	174	68.09	7900	2.3				
21	167	65.36	7930	2.4				
16	220	86.53	3960	0.90				
17	205	80.65	4200	0.95				
20	181	70.50	4550	1.10				
21	169	66.09	4680	1.20				
24	149	58.32	4890	1.35				
25	140	54.54	4970	1.45	FA	37	71M2-4	18
27	132	51.70	5030	1.50	FAF	37	71M2-4	19
29	120	47.02	5120	1.65	F	37	71M2-4	18
31	112	43.83	5180	1.80	FF	37	71M2-4	20
36	98	38.31	5270	2.0				
38	92	35.91	5300	2.2				
44	81	31.69	5300	2.5				
49	72	28.09	5140	2.8				
58	61	23.88	4930	3.3				

P <sub>1</sub> = 0.55 kW								
0.22	20500	6295	91800	0.90	FA	157 R97	80M1-4	770
0.25	17200	5404	102700	1.05	FAF	157 R97	80M1-4	820
0.49	8820	2780	118800	2.0	F	157 R97	80M1-4	790
					FF	157 R97	80M1-4	890
0.56	7800	2427	120000	2.3	FA	157 R97	80M1-4	760
0.81	5530	1674	120000	3.3	FAF	157 R97	80M1-4	820
1.0	4270	1308	120000	4.2	F	157 R97	80M1-4	780
1.2	3750	1169	120000	4.8	FF	157 R97	80M1-4	890



## 技术参数

## Technical Data

P <sub>1</sub> = 0.55 kW								
N <sub>A</sub> rpm	M <sub>2</sub> Nm	i	Fr <sub>2</sub> MAX[N]	f <sub>s</sub>	Type	Gear unit	Motor size	 Kg
0.35	13400	3926	87700	0.90	FA	127 R77	80M1-4	430
0.39	11800	3454	90000	1.00	FAF	127 R77	80M1-4	465
0.45	10300	3031	90000	1.15	F	127 R77	80M1-4	465
					FF	127 R77	80M1-4	510
0.57	8250	2369	48300	0.95				
0.66	7200	2068	51100	1.05				
0.74	6190	1826	53600	1.25				
0.85	5540	1597	55100	1.40	FA	107 R77	80M1-4	275
0.97	4830	1401	56700	1.60	FAF	107 R77	80M1-4	300
1.1	4220	1243	58000	1.80	F	107 R77	80M1-4	295
1.2	3770	1087	58900	2.0	FF	107 R77	80M1-4	320
1.4	3220	950	60000	2.4				
1.6	2800	834	60800	2.7				
2.1	2180	640	61900	3.5				
1.0	4630	1327	28900	0.95				
1.2	4150	1171	30300	1.05				
1.3	3630	1022	31800	1.20				
1.5	3110	898	33100	1.40	FA	97 R57	80M1-4	185
1.7	2750	784	33900	1.55	FAF	97 R57	80M1-4	210
2.0	2380	690	34600	1.80	F	97 R57	80M1-4	195
2.2	2100	605	35200	2.1	FF	97 R57	80M1-4	225
2.6	1830	529	35700	2.4				
2.9	1610	467	36100	2.7				
3.4	1390	406	36500	3.1				
3.7	1240	363	36700	3.5				
1.5	3110	887	15200	0.95				
1.7	2720	780	24000	1.10	FA	87 R57	80M1-4	120
2.0	2330	674	25400	1.30	FAF	87 R57	80M1-4	135
2.2	2120	609	26100	1.40	F	87 R57	80M1-4	125
2.6	1790	515	27000	1.70	FF	87 R57	80M1-4	145
3.0	1580	452	27600	1.90				
3.9	1180	345	28600	2.5				
2.8	1690	480	14300	0.90	FA	77 R37	80M1-4	69
3.3	1450	413	16100	1.05	FAF	77 R37	80M1-4	75
3.7	1290	367	17000	1.15	F	77 R37	80M1-4	73
4.2	1150	323	17700	1.30	FF	77 R37	80M1-4	83
5.3	910	257	9470	0.90	FA	67 R37	80M1-4	47
5.9	810	231	10400	1.00	FAF	67 R37	80M1-4	53
6.6	720	205	11100	1.15	F	67 R37	80M1-4	49
7.8	615	175	11800	1.35	FF	67 R37	80M1-4	55



## 技术参数

## Technical Data

P <sub>1</sub> = 0.55 kW								
N <sub>A</sub> rpm	M <sub>2</sub> Nm	i	Fr <sub>2</sub> MAX[N]	f <sub>s</sub>	Type	Gear unit	Motor size	 Kg
2.5	2140	276.77	35100	2.0	FA	97	90L-8	170
2.7	1960	253.41	35500	2.2	FAF	97	90L-8	190
3.0	1730	223.88	35900	2.5	F	97	90L-8	175
					FF	97	90L-8	210
2.5	2090	270.68	26200	1.45	FA	87	90L-8	105
2.7	1970	255.37	26500	1.50	FAF	87	90L-8	120
3.0	1770	228.93	27100	1.70	F	87	90L-8	110
3.5	1520	197.20	27800	1.95	FF	87	90L-8	125
3.3	1580	270.68	27600	1.90	FA	87	80M2-6	100
3.5	1490	255.37	27800	2.0	FAF	87	80M2-6	115
3.9	1340	228.93	28200	2.3	F	87	80M2-6	105
4.6	1150	197.20	28700	2.6	FF	87	80M2-6	120
5.0	1050	179.97	28900	2.9				
4.0	1320	225.79	16800	1.15				
4.5	1160	198.31	17600	1.30	FA	77	80M2-6	61
4.8	1100	188.40	17900	1.35	FAF	77	80M2-6	68
5.4	970	166.47	18400	1.55	F	77	80M2-6	65
6.3	830	142.27	18900	1.80	FF	77	80M2-6	76
6.9	760	130.42	19100	1.95				
6.0	870	225.79	18800	1.70				
6.9	765	198.31	19100	1.95				
7.2	730	188.40	19200	2.1	FA	77	80M1-4	59
8.2	645	166.47	19400	2.3	FAF	77	80M1-4	66
9.6	550	142.27	19600	2.7	F	77	80M1-4	63
10	505	130.42	19700	3.0	FF	77	80M1-4	74
12	440	114.45	19800	3.4				
13	420	108.46	19800	3.6				
14	365	94.93	19900	4.1				
7.0	755	195.39	10900	1.10				
8.0	660	170.85	11500	1.25				
8.4	625	162.31	11700	1.30	FA	67	80M1-4	36
9.6	550	142.40	12200	1.50	FAF	67	80M1-4	43
11	465	120.79	12600	1.75	F	67	80M1-4	39
12	420	109.04	12700	1.95	FF	67	80M1-4	45
14	370	95.94	12900	2.2				
15	350	90.59	13000	2.3				
17	310	79.76	13000	2.7				



## 技术参数

## Technical Data

P <sub>1</sub> = 0.55 kW								
N <sub>A</sub> rpm	M <sub>2</sub> Nm	i	Fr <sub>2MAX</sub> [N]	f <sub>s</sub>	Type	Gear unit	Motor size	 Kg
8.7	605	157.09	9150	1.00				
10	525	136.16	9750	1.15				
11	490	127.27	9980	1.20				
12	425	110.01	10400	1.40	FA	57	80M1-4	32
15	360	93.47	10800	1.65	FAF	57	80M1-4	38
16	320	83.46	11000	1.85	F	57	80M1-4	33
19	280	72.98	11200	2.1	FF	57	80M1-4	39
20	265	68.22	11300	2.3				
23	230	58.97	11500	2.6				
13	405	105.09	5840	1.00				
15	345	89.29	6620	1.15				
17	310	79.72	6990	1.30	FA	47	80M1-4	24
20	265	68.09	7370	1.50	FAF	47	80M1-4	27
21	250	65.36	7440	1.60	F	47	80M1-4	25
24	220	56.49	7670	1.85	FF	47	80M1-4	28
28	185	48.00	7850	2.2				
32	166	42.86	7940	2.4				
23	225	58.32	3890	0.90				
25	210	54.54	4140	0.95				
26	200	51.70	4300	1.00				
29	182	47.02	4540	1.10	FA	37	80M1-4	20
31	169	43.83	4680	1.20	FAF	37	80M1-4	21
36	148	38.31	4900	1.35	F	37	80M1-4	20
38	139	35.91	4980	1.45	FF	37	80M1-4	22
43	122	31.69	4990	1.65				
48	109	28.09	4870	1.85				
57	92	23.88	4700	2.2				
58	91	23.63	4690	2.2	FA	37	80M1-4	19
66	79	20.57	4540	2.5	FAF	37	80M1-4	21
71	74	19.27	4470	2.7	F	37	80M1-4	20
80	66	17.03	4340	3.0	FF	37	80M1-4	22
95	55	14.33	4150	3.6				

P <sub>1</sub> = 0.75 kW									
0.50	12200	2780	113700	1	.45	FA	157 R97	80M2-4	770
						FAF	157 R97	80M2-4	830
						F	157 R97	80M2-4	790
						FF	157 R97	80M2-4	890
0.57	10800	2427	116000	1.65		FA	157 R97	80M2-4	760
0.82	7630	1674	120000	2.4		FAF	157 R97	80M2-4	820
1.1	5910	1308	120000	3.1		F	157 R97	80M2-4	780
1.2	5210	1169	120000	3.5		FF	157 R97	80M2-4	890



## 技术参数

## Technical Data

P <sub>1</sub> = 0.75 kW																	
N <sub>A</sub> rpm	M <sub>2</sub> Nm	i	Fr <sub>2</sub> MAX[N]	f <sub>s</sub>	Type	Gear unit	Motor size	 Kg									
0.46	14000	3031	86500	0.85	FA	127 R77	80M2-4	430									
					FAF	127 R77	80M2-4	470									
					F	127 R77	80M2-4	465									
					FF	127 R77	80M2-4	510									
0.52	12600	2672	89200	0.95	FA	127 R77	80M2-4	430									
					0.59	11100	2357	90000	1.10	FAF	127 R77	80M2-4	465				
					0.68	9540	2038	90000	1.25	F	127 R77	80M2-4	465				
					0.77	8310	1784	90000	1.45	FF	127 R77	80M2-4	510				
					0.86	7450	1606	90000	1.60								
1.4	4900	1022	18500	0.90	FA	97 R57	80M2-4	190									
									1.5	4230	898	30100	1.00	FAF	97 R57	80M2-4	210
									1.8	3730	784	31500	1.15	F	97 R57	80M2-4	195
									2.0	3250	690	32700	1.30	FF	97 R57	80M2-4	230
									2.3	2860	605	33600	1.50				
									2.6	2490	529	34400	1.75				
									3.0	2200	467	35000	1.95				
									3.4	1890	406	35600	2.3				
									3.8	1700	363	35900	2.5				
2.0	3170	674	11300	0.95	FA	87 R57	80M2-4	120									
									2.3	2880	609	23400	1.05	FAF	87 R57	80M2-4	135
									2.7	2430	515	25000	1.25	F	87 R57	80M2-4	130
									3.1	2140	452	26000	1.40	FF	87 R57	80M2-4	145
									4.0	1610	345	27500	1.85				
3.8	1750	367	13800	0.85	FA	77 R37	80M2-4	70									
									4.3	1550	323	15400	0.95	FAF	77 R37	80M2-4	76
									4.9	1340	280	16700	1.10	F	77 R37	80M2-4	74
														FF	77 R37	80M2-4	84
2.7	2640	254.40	61100	2.9	FA	107	100L1-8	255									
									FAF	107	100L1-8	275					
									F	107	100L1-8	270					
									FF	107	100L1-8	300					
2.5	2870	276.77	33600	1.50	FA	97	100L1-8	180									
									2.7	2630	253.41	34100	1.65	FAF	97	100L1-8	200
									3.1	2320	223.88	34800	1.85	F	97	100L1-8	185
														FF	97	100L1-8	220
3.2	2200	276.77	35000	1.95	FA	97	90S-6	170									
									3.6	2020	253.41	35400	2.1	FAF	97	90S-6	190
									4.0	1780	223.88	35800	2.4	F	97	90S-6	175
														FF	97	90S-6	210





## 技术参数

## Technical Data

P <sub>1</sub> = 0.75 kW								
NA rpm	M <sub>2</sub> Nm	i	Fr <sub>2</sub> MAX[N]	f <sub>s</sub>	Type	Gear unit	Motor size	 Kg
3.3	2150	270.68	26000	1.40				
3.5	2030	255.37	26300	1.50	FA	87	90S-6	105
3.9	1820	228.93	27000	1.65	FAF	87	90S-6	120
4.6	1570	197.20	27600	1.90	F	87	90S-6	110
5.0	1430	179.97	28000	2.1	FF	87	90S-6	125
5.6	1270	159.61	28400	2.4				
5.1	1400	270.68	28100	2.1	FA	87	80M2-4	100
5.4	1330	255.37	28200	2.3	FAF	87	80M2-4	115
6.0	1190	228.93	28600	2.5	F	87	80M2-4	105
					FF	87	80M2-4	120
4.5	1580	198.31	15200	0.95	FA	77	90S-6	66
4.8	1500	188.40	15700	1.00	FAF	77	90S-6	73
5.4	1320	166.47	16800	1.15	F	77	90S-6	70
6.3	1130	142.27	17800	1.30	FF	77	90S-6	81
6.9	1040	130.42	18200	1.45				
6.1	1170	225.79	17600	1.30	FA	77	80M2-4	61
7.0	1030	198.31	18200	1.45	FAF	77	80M2-4	68
7.3	980	188.40	18400	1.55	F	77	80M2-4	65
					FF	77	80M2-4	76
8.3	860	166.47	18800	1.75	FA	77	80M2-4	61
9.7	740	142.27	19200	2.0	FAF	77	80M2-4	68
11	675	130.42	19300	2.2	F	77	80M2-4	65
12	595	114.45	19500	2.5	FF	77	80M2-4	76
13	565	108.46	19600	2.7				
8.1	890	170.85	9670	0.90	FA	67	80M2-4	37
8.5	840	162.31	10100	0.95	FAF	67	80M2-4	44
9.7	740	142.40	11000	1.10	F	67	80M2-4	40
11	625	120.79	11700	1.30	FF	67	80M2-4	46
13	565	109.04	12100	1.45				
14	500	95.94	12400	1.65	FA	67	80M2-4	37
15	470	90.59	12500	1.75	FAF	67	80M2-4	44
17	415	79.76	12800	2.0	F	67	80M2-4	40
20	350	67.65	13000	2.3	FF	67	80M2-4	46
23	315	61.07	13000	2.6				
11	660	127.27	5290	0.90				
13	570	110.01	9420	1.05	FA	57	80M2-4	33
15	485	93.47	10000	1.25	FAF	57	80M2-4	39
17	435	83.46	10400	1.40	F	57	80M2-4	34
19	380	72.98	10700	1.60	FF	57	80M2-4	40
20	355	68.22	10800	1.70				



## 技术参数

## Technical Data

P <sub>1</sub> = 0.75 kW								
NA rpm	M <sub>2</sub> Nm	i	Fr <sub>2</sub> MAX[N]	f <sub>s</sub>	Type	Gear unit	Motor size	 Kg
23	305	58.97	11100	1.95	FA	57	80M2-4	33
28	260	50.10	11300	2.3	FAF	57	80M2-4	39
31	230	44.73	11400	2.6	F	57	80M2-4	34
					FF	57	80M2-4	40
17	415	79.72	5060	0.95	FA	47	80M2-4	25
20	355	68.09	6520	1.15	FAF	47	80M2-4	28
21	340	65.36	6680	1.20	F	47	80M2-4	26
					FF	47	80M2-4	29
24	295	56.49	7120	1.35				
29	250	48.00	7470	1.60	FA	47	80M2-4	25
32	220	42.86	7640	1.80	FAF	47	80M2-4	28
38	190	36.61	7820	2.1	F	47	80M2-4	26
40	178	34.29	7850	2.3	FF	47	80M2-4	29
48	150	28.88	7540	2.7				
29	245	47.02	3530	0.80				
31	230	43.83	3850	0.90	FA	37	80M2-4	21
36	199	38.31	4310	1.00	FAF	37	80M2-4	22
38	186	35.91	4480	1.05	F	37	80M2-4	21
44	165	31.69	4620	1.20	FF	37	80M2-4	23
49	146	28.09	4540	1.35				
58	123	23.63	4400	1.65				
67	107	20.57	4290	1.85	FA	37	80M2-4	20
72	100	19.27	4240	2.0	FAF	37	80M2-4	22
81	88	17.03	4130	2.3	F	37	80M2-4	21
96	74	14.33	3970	2.7	FF	37	80M2-4	23
107	67	12.87	3870	3.0				
P <sub>1</sub> = 1.1 kW								
0.50	18200	2780	99600	1.00	FA	157 R97	90S-4	770
					FAF	157 R97	90S-4	830
					F	157 R97	90S-4	790
					FF	157 R97	90S-4	900
0.58	16100	2427	105500	1.10				
0.64	14400	2185	109500	1.25				
0.72	12800	1944	112700	1.40				
0.84	11300	1674	115300	1.60	FA	157 R97	90S-4	770
1.1	8750	1308	118900	2.1	FAF	157 R97	90S-4	830
1.2	7750	1169	120000	2.3	F	157 R97	90S-4	790
1.5	6200	953	120000	2.9	FF	157 R97	90S-4	900
1.7	5420	845	120000	3.3				
3.1	2870	446	120000	6.3				
4.6	1940	302	120000	9.3				

**技术参数****Technical Data**

<b>P<sub>1</sub> = 1.1 kW</b>								
<b>N<sub>A</sub></b> rpm	<b>M<sub>2</sub></b> Nm	<b>i</b>	<b>Fr<sub>2MAX</sub></b> [N]	<b>f<sub>s</sub></b>	<b>Type</b>	<b>Gear unit</b>	<b>Motor size</b>	 Kg
0.69	14000	2038	86600	0.85				
0.79	12200	1784	90000	1.00	FA	127 R77	90S-4	435
0.87	11000	1606	90000	1.10	FAF	127 R77	90S-4	470
1.0	9480	1390	90000	1.25	F	127 R77	90S-4	470
1.2	8280	1220	90000	1.45	FF	127 R77	90S-4	520
1.3	7360	1077	90000	1.65				
1.1	8480	1243	47600	0.90				
1.3	7490	1087	50300	1.00	FA	107 R77	90S-4	285
1.5	6480	950	52900	1.20	FAF	107 R77	90S-4	305
1.7	5660	834	54800	1.35	F	107 R77	90S-4	300
1.9	4970	736	56400	1.55	FF	107 R77	90S-4	330
2.2	4380	640	57600	1.75				
2.0	4750	690	25100	0.90				
2.3	4170	605	30300	1.05	FA	97 R57	90S-4	195
2.6	3640	529	31700	1.20	FAF	97 R57	90S-4	215
3.0	3210	467	32800	1.35	F	97 R57	90S-4	200
3.5	2770	406	33800	1.55	FF	97 R57	90S-4	235
3.9	2490	363	34400	1.75				
3.1	3130	452	14100	0.95	FA	87 R57	90S-4	125
4.1	2360	345	25300	1.25	FAF	87 R57	90S-4	140
4.7	2050	300	26300	1.45	F	87 R57	90S-4	135
5.6	1700	249	27300	1.75	FF	87 R57	90S-4	150
2.6	3990	254.40	58500	1.95	FA	107	100L2-8	260
3.1	3380	215.37	59700	2.3	FAF	107	100L2-8	280
3.4	3120	199.31	60200	2.5	F	107	100L2-8	275
3.8	2800	178.64	60800	2.7	FF	107	100L2-8	300
3.3	3160	276.77	32900	1.35	FA	97	90L-6	170
3.6	2890	253.41	33600	1.50	FAF	97	90L-6	190
4.1	2560	223.88	34300	1.70	F	97	90L-6	175
4.8	2170	189.92	35100	2.0	FF	97	90L-6	210
5.3	2000	174.87	35400	2.2				
5.1	2080	276.77	35200	2.1	FA	97	90S-4	170
5.5	1900	253.41	35600	2.3	FAF	97	90S-4	190
6.2	1680	223.88	36000	2.6	F	97	90S-4	175
					FF	97	90S-4	210
3.4	3090	270.68	16000	0.95				
3.6	2920	255.37	22700	1.05	FA	87	90L-6	105
4.0	2610	228.93	24400	1.15	FAF	87	90L-6	120
4.7	2250	197.20	25700	1.35	F	87	90L-6	110
5.1	2050	179.97	26300	1.45	FF	87	90L-6	125
5.8	1820	159.61	27000	1.65				



技术参数

Technical Data

P <sub>1</sub> = 1.1 kW								
N <sub>A</sub> rpm	M <sub>2</sub> Nm	i	Fr <sub>2</sub> MAX[N]	f <sub>s</sub>	Type	Gear unit	Motor size	 Kg
5.2	2030	270.68	26300	1.50				
5.5	1920	255.37	26700	1.55				
6.1	1720	228.93	27200	1.75	FA	87	90S-4	105
7.1	1480	197.20	27900	2.0	FAF	87	90S-4	120
7.8	1350	179.97	28200	2.2	F	87	90S-4	110
8.8	1200	159.61	28500	2.5	FF	87	90S-4	125
10	1010	134.16	29000	3.0				
11	930	123.29	29100	3.2				
7.1	1490	198.31	15800	1.00				
7.4	1410	188.40	16300	1.05				
8.4	1250	166.47	17200	1.20				
9.8	1070	142.27	18000	1.40	FA	77	90S-4	66
11	980	130.42	18400	1.55	FAF	77	90S-4	73
12	860	114.45	18800	1.75	F	77	90S-4	70
13	810	108.46	18900	1.85	FF	77	90S-4	81
15	710	94.93	19200	2.1				
16	640	85.52	19400	2.3				
19	565	75.02	19600	2.7				
12	910	120.79	9460	0.90				
13	820	109.04	10300	1.00				
15	720	95.94	11100	1.15				
15	680	90.59	11400	1.20				
18	600	79.76	11900	1.35	FA	67	90S-4	42
21	510	67.65	12400	1.60	FAF	67	90S-4	49
23	460	61.07	12600	1.80	F	67	90S-4	45
26	405	53.73	12800	2.0	FF	67	90S-4	51
28	380	50.74	12900	2.2				
32	325	43.20	13000	2.5				
36	295	39.26	13000	2.7				
41	255	34.01	13000	2.9				
17	625	83.46	8470	0.95				
19	550	72.98	9590	1.10				
21	510	68.22	9840	1.15				
24	440	58.97	10300	1.35	FA	57	90S-4	38
28	375	50.10	10700	1.60	FAF	57	90S-4	44
31	335	44.73	10700	1.80	F	57	90S-4	39
37	285	38.21	10400	2.1	FF	57	90S-4	45
39	270	35.79	10200	2.2				
46	225	30.15	9810	2.6				
25	425	56.49	3730	0.95	FA	47	90S-4	31
29	360	48.00	6440	1.10	FAF	47	90S-4	33
					F	47	90S-4	32
					FF	47	90S-4	35



## 技术参数

## Technical Data

<b>P<sub>1</sub> = 1.1 kW</b>								
-------------------------------	--	--	--	--	--	--	--	--

<b>N<sub>A</sub></b> rpm	<b>M<sub>2</sub></b> Nm	<b>i</b>	<b>Fr<sub>2MAX</sub>[N]</b>	<b>f<sub>s</sub></b>	<b>Type</b>	<b>Gear unit</b>	<b>Motor size</b>	 Kg
33	320	42.86	6860	1.25	FA	47	90S-4	31
38	275	36.61	7280	1.45	FAF	47	90S-4	33
41	255	34.29	7260	1.55	F	47	90S-4	32
48	215	28.88	7040	1.85	FF	47	90S-4	35
<hr/>								
45	230	30.86	7130	1.75	FA	47	90S-4	30
48	220	29.32	7060	1.80	FAF	47	90S-4	33
54	193	25.72	6880	2.1	F	47	90S-4	31
64	164	21.82	6640	2.4	FF	47	90S-4	34
71	148	19.70	6490	2.7				
<hr/>								
44	240	31.69	3660	0.85	FA	37	90S-4	26
50	210	28.09	3970	0.95	FAF	37	90S-4	27
59	179	23.88	3930	1.10	F	37	90S-4	26
					FF	37	90S-4	28
<hr/>								
68	154	20.57	3870	1.30				
73	145	19.27	3840	1.40				
82	128	17.03	3780	1.55	FA	37	90S-4	26
98	108	14.33	3680	1.85	FAF	37	90S-4	27
109	97	12.87	3610	2.1	F	37	90S-4	26
126	83	11.08	3500	2.3	FF	37	90S-4	28
134	78	10.42	3460	2.4				
156	67	8.97	3350	2.6				

<b>P<sub>1</sub> = 1.5 kW</b>								
-------------------------------	--	--	--	--	--	--	--	--

0.58	22200	2427	83000	0.80				
0.65	19800	2185	94400	0.90				
0.73	17600	1944	101300	1.00				
0.84	15500	1674	107000	1.15	FA	157 R97	90L-4	770
1.1	12000	1308	114100	1.50	FAF	157 R97	90L-4	830
1.2	10700	1169	116300	1.70	F	157 R97	90L-4	790
1.5	8580	953	119100	2.1	FF	157 R97	90L-4	900
1.7	7540	845	120000	2.4				
3.2	3980	446	120000	4.5				
4.7	2700	302	120000	6.7				



## 技术参数

## Technical Data

P <sub>1</sub> = 1.5kW								
N <sub>A</sub> rpm	M <sub>2</sub> Nm	i	Fr <sub>2</sub> MAX[N]	f <sub>s</sub>	Type	Gear unit	Motor size	 Kg
0.88	15000	1606	84600	0.80				
1.0	13000	1390	88600	0.95				
1.2	11300	1220	90000	1.05	FA	127 R77	90L-4	435
1.3	10100	1077	90000	1.20	FAF	127 R77	90L-4	475
1.5	8630	930	90000	1.40	F	127 R77	90L-4	470
1.7	7590	820	90000	1.60	FF	127 R77	90L-4	520
1.9	6710	727	90000	1.80				
2.2	6050	648	90000	2.0				
1.5	8850	950	46600	0.85				
1.7	7740	834	49700	1.00				
1.9	6810	736	52100	1.15	FA	107 R77	90L-4	285
2.2	5980	640	54100	1.30	FAF	107 R77	90L-4	305
2.5	5170	560	55900	1.50	F	107 R77	90L-4	300
2.9	4520	489	57400	1.70	FF	107 R77	90L-4	330
3.2	4070	436	58300	1.90				
3.8	3450	370	59500	2.2				
2.7	4960	529	15500	0.85	FA	97 R57	90L-4	195
3.0	4380	467	29700	1.00	FAF	97 R57	90L-4	215
3.5	3790	406	31300	1.15	F	97 R57	90L-4	200
3.9	3400	363	32400	1.25	FF	97 R57	90L-4	235
4.7	2800	300	23700	1.05	FA	87 R57	90L-4	130
5.7	2320	249	25400	1.30	FAF	87 R57	90L-4	140
					F	87 R57	90L-4	135
					FF	87 R57	90L-4	150
2.8	5210	254.40	55900	1.50	FA	107	112M-8	265
3.2	4410	215.37	57600	1.75	FAF	107	112M-8	285
3.5	4080	199.31	58300	1.90	F	107	112M-8	280
3.9	3660	178.64	59100	2.1	FF	107	112M-8	305
3.6	3960	254.40	58500	1.95	FA	107	100L-6	255
4.3	3350	215.37	59700	2.3	FAF	107	100L-6	275
4.6	3100	199.31	60200	2.5	F	107	100L-6	270
5.2	2780	178.64	60800	2.8	FF	107	100L-6	300



## 技术参数

## Technical Data

P <sub>1</sub> = 1.5kW								
NA rpm	M <sub>2</sub> Nm	i	Fr <sub>2</sub> MAX[N]	f <sub>s</sub>	Type	Gear unit	Motor size	 Kg
3.3	4310	276.77	29900	1.00	FA FAF F FF	97	100L-6	180
3.6	3950	253.41	30900	1.10				
4.1	3490	223.88	32100	1.25				
4.8	2960	189.92	33400	1.45				
5.3	2720	174.87	33900	1.60				
5.1	2810	276.77	33700	1.55	FA FAF F FF	97	90L-4	170
5.6	2570	253.41	34300	1.65				
6.3	2270	223.88	34900	1.90				
7.4	1930	189.92	35500	2.2				
8.1	1780	174.87	35800	2.4				
5.2	2750	270.68	23900	1.10	FA FAF F FF	87	90L-4	105
5.5	2590	255.37	24500	1.15				
6.2	2330	228.93	25400	1.30				
7.2	2000	197.20	26400	1.50				
7.8	1830	179.97	26900	1.65	FA FAF F FF	87	90L-4	105
8.8	1620	159.61	27500	1.85				
11	1360	134.16	28200	2.2				
13	1110	109.49	28700	2.7				
14	990	97.89	29000	3.0				
8.5	1690	166.47	14300	0.90	FA FAF F FF	77	90L-4	67
9.9	1450	142.27	16100	1.05				
11	1320	130.42	16800	1.15				
12	1160	114.45	17600	1.30				
13	1100	108.46	17900	1.35	FA FAF F FF	77	90L-4	67
15	960	94.93	18400	1.55				
16	870	85.52	18800	1.75				
19	760	75.02	19100	1.95				
19	735	72.50	19200	2.0				
21	675	66.46	19300	2.2				
24	595	58.32	19500	2.5				
26	560	55.27	19600	2.7				
29	490	48.37	19700	3.1				
32	445	43.58	19800	3.4				
37	390	38.23	19900	3.9				
39	370	36.58	19900	3.0				
45	320	31.51	20000	4.3				
16	920	90.59	9300	0.90	FA FAF F FF	67	90L-4	44
18	810	79.76	10400	1.00				
21	685	67.65	11400	1.20				
23	620	61.07	11800	1.30				



## 技术参数

## Technical Data

P <sub>1</sub> = 1.5kW								
N <sub>A</sub> rpm	M <sub>2</sub> Nm	i	Fr <sub>2</sub> MAX[N]	f <sub>s</sub>	Type	Gear unit	Motor size	 Kg
26	545	53.73	12200	1.50	FA	67	90L-4	44
28	515	50.74	12300	1.60	FAF	67	90L-4	51
33	440	43.20	12700	1.85	F	67	90L-4	47
36	400	39.26	12800	1.95	FF	67	90L-4	53
39	370	36.30	12900	2.2	FA	67	90L-4	43
44	325	32.08	13000	2.5	FAF	67	90L-4	50
51	280	27.41	13000	2.9	F	67	90L-4	46
56	255	25.13	13000	3.2	FF	67	90L-4	52
24	600	58.97	9210	1.00				
28	510	50.10	9860	1.20	FA	57	90L-4	40
32	455	44.73	9990	1.30	FAF	57	90L-4	46
37	390	38.21	9740	1.55	F	57	90L-4	41
39	365	35.79	9620	1.65	FF	57	90L-4	47
47	305	30.15	9310	1.95				
33	435	42.86	575	0.90	FA	47	90L-4	32
39	370	36.61	6300	1.10	FAF	47	90L-4	35
41	350	34.29	6580	1.15	F	47	90L-4	33
49	295	28.88	6500	1.35	FF	47	90L-4	36
46	315	30.86	6550	1.30				
48	300	29.32	6510	1.35				
55	260	25.72	6390	1.55	FA	47	90L-4	31
65	220	21.82	6230	1.80	FAF	47	90L-4	34
72	200	19.70	6110	2.0	F	47	90L-4	32
81	176	17.33	5970	2.3	FF	47	90L-4	35
86	166	16.36	5900	2.4				
101	142	13.93	5700	2.8				
69	210	20.57	3410	0.95				
73	196	19.27	3410	1.00				
83	173	17.03	3400	1.15	FA	37	90L-4	27
98	146	14.33	3350	1.35	FAF	37	90L-4	29
110	131	12.87	3310	1.55	F	37	90L-4	28
127	113	11.08	3250	1.70	FF	37	90L-4	29
135	106	10.42	3220	1.75				
157	91	8.97	3140	1.90				
176	81	8.01	3080	2.1				
P <sub>1</sub> = 2.2kW								
0.98	18700	1441	98000	0.95	FA	157 R97	100L1-4	780
					FAF	157 R97	100L1-4	840
					F	157 R97	100L1-4	800
					FF	157 R97	100L1-4	910





## 技术参数

## Technical Data

P <sub>1</sub> = 2.2kW								
N <sub>A</sub> rpm	M <sub>2</sub> Nm	i	Fr <sub>2</sub> MAX[N]	f <sub>s</sub>	Type	Gear unit	Motor size	 Kg
1.1	17900	1308	100700	1.00				
1.2	15900	1169	106000	1.15				
1.5	12800	953	112600	1.40				
1.7	11300	845	115300	1.60				
1.9	10200	764	117000	1.75	FA	157 R97	100L1-4	780
2.1	9040	680	118500	2.0	FAF	157 R97	100L1-4	840
2.5	7580	576	120000	2.4	F	157 R97	100L1-4	800
3.2	5970	446	120000	3.0	FF	157 R97	100L1-4	910
4.7	4040	302	120000	4.5				
5.2	3630	273	120000	5.0				
6.1	3050	232	120000	5.9				
7.2	2590	197	120000	7.0				
1.3	14900	1077	84800	0.80				
1.5	12800	930	88900	0.95				
1.7	11300	820	90000	1.05	FA	127 R77	100L1-4	445
1.9	9960	727	90000	1.20	FAF	127 R77	100L1-4	480
2.2	8940	648	90000	1.35	F	127 R77	100L1-4	480
2.6	7580	549	90000	1.60	FF	127 R77	100L1-4	520
2.9	6820	495	90000	1.75				
3.3	5900	428	90000	2.0				
2.2	8830	640	46600	0.85				
2.5	7670	560	49800	1.00	FA	107 R77	100L1-4	290
2.9	6700	489	52300	1.15	FAF	107 R77	100L1-4	315
3.2	6010	436	54000	1.30	F	107 R77	100L1-4	310
3.8	5100	370	56100	1.50	FF	107 R77	100L1-4	335
4.2	4590	333	57200	1.65				
4.9	3950	285	30900	1.10	FA	97 R57	100L1-4	200
5.8	3390	245	32400	1.25	FAF	97 R57	100L1-4	225
					F	97 R57	100L1-4	210
					FF	97 R57	100L1-4	240
2.8	7640	254.40	49900	1.00	FA	107	132S-8	270
3.2	6460	215.37	52900	1.20	FAF	107	132S-8	290
3.5	5980	199.31	54100	1.30	F	107	132S-8	285
3.9	5360	178.64	55500	1.45	FF	107	132S-8	315
3.7	5690	254.40	54800	1.35	FA	107	112M-6	265
4.4	4810	215.37	56700	1.60	FAF	107	112M-6	285
4.7	4450	199.31	57500	1.70	F	107	112M-6	280
5.3	3990	178.64	58400	1.90	FF	107	112M-6	305



## 技术参数

## Technical Data

P <sub>1</sub> = 2.2kW								
NA rpm	M <sub>2</sub> Nm	i	Fr <sub>2</sub> MAX[N]	f <sub>s</sub>	Type	Gear unit	Motor size	 Kg
5.5	3790	254.40	58900	2.0	FA	107	100L1-4	255
6.5	3210	215.37	60000	2.4	FAF	107	100L1-4	275
7.1	2970	199.31	60400	2.6	F	107	100L1-4	270
7.9	2660	178.64	61000	2.9	FF	107	100L1-4	300
4.2	5000	223.88	12400	0.85	FA	97	112M-6	190
5.0	4240	189.92	30100	1.00	FAF	97	112M-6	210
5.4	3910	174.87	31000	1.10	F	97	112M-6	195
6.0	3490	156.30	32100	1.25	FF	97	112M-6	230
5.1	4120	276.77	30400	1.05				
5.6	3780	253.41	31400	1.15				
6.3	3340	223.88	32500	1.30	FA	97	100L1-4	180
7.4	2830	189.92	33700	1.50	FAF	97	100L1-4	200
8.1	2610	174.87	34200	1.65	F	97	100L1-4	185
9.0	2330	156.30	34800	1.85	FF	97	100L1-4	220
10	2100	140.71	35200	2.1				
11	1900	127.42	35600	2.3				
7.2	2940	197.20	22000	1.00	FA	87	100L1-4	115
7.8	2680	179.97	24200	1.10	FAF	87	100L1-4	125
8.8	2380	159.61	25200	1.25	F	87	100L1-4	120
11	2000	134.16	26400	1.50	FF	87	100L1-4	135
11	1840	123.29	26900	1.65				
13	1630	109.49	27500	1.85				
14	1460	97.89	27900	2.1	FA	87	100L1-4	115
16	1310	88.01	28300	2.3	FAF	87	100L1-4	125
18	1140	76.39	27800	2.6	F	87	100L1-4	120
21	1020	68.40	27100	2.9	FF	87	100L1-4	135
25	850	56.75	25900	3.6				
28	750	50.36	25200	3.9				
31	675	45.28	24500	4.2				
12	1710	114.45	14200	0.90	FA	77	100L1-4	74
13	1620	108.46	14900	0.95	FAF	77	100L1-4	81
15	1410	94.93	16300	1.05	F	77	100L1-4	78
16	1270	85.52	17100	1.20	FF	77	100L1-4	89
19	1120	75.02	17800	1.35				
21	990	66.46	18300	1.50	FA	77	100L1-4	74
24	870	58.32	18800	1.75	FAF	77	100L1-4	81
26	820	55.27	18900	1.80	F	77	100L1-4	78
29	720	48.37	19200	2.1	FF	77	100L1-4	89
32	650	43.58	19400	2.3				



## 技术参数

## Technical Data

P <sub>1</sub> = 2.2kW								
Na rpm	M <sub>2</sub> Nm	i	Fr <sub>2</sub> MAX[N]	f <sub>s</sub>	Type	Gear unit	Motor size	 Kg
39	545	36.58	19600	2.0	FA	77	100L1-4	73
45	470	31.51	19700	2.9	FAF	77	100L1-4	79
49	430	28.75	19800	3.3	F	77	100L1-4	77
55	380	25.50	19900	4.0	FF	77	100L1-4	87
23	910	61.07	9420	0.90				
26	800	53.73	10500	1.00				
28	755	50.74	10800	1.10				
33	645	43.20	11600	1.25				
36	585	39.26	12000	1.35	FA	67	100L1-4	51
41	505	34.01	12400	1.45	FAF	67	100L1-4	58
44	480	32.08	12500	1.70	F	67	100L1-4	54
51	410	27.41	12800	2.0	FF	67	100L1-4	60
56	375	25.13	12900	2.2				
64	330	22.05	13000	2.5				
67	310	20.90	13000	2.6				
77	275	18.29	13000	3.0				
32	665	44.73	4480	0.90				
37	570	38.21	8660	1.05				
39	535	35.79	8620	1.15	FA	57	100L1-4	47
47	450	30.15	8460	1.30	FAF	57	100L1-4	53
56	370	24.96	8240	1.55	F	57	100L1-4	48
67	315	21.17	8020	1.90	FF	57	100L1-4	54
74	285	19.11	7870	2.1				
84	250	16.81	7670	2.4				
89	235	15.88	7580	2.5				
55	385	25.72	5560	1.05				
65	325	21.82	5520	1.25				
72	295	19.70	5480	1.35	FA	47	100L1-4	38
81	260	17.33	5410	1.55	FAF	47	100L1-4	40
86	245	16.36	5370	1.65	F	47	100L1-4	38
101	210	13.93	5250	1.95	FF	47	100L1-4	42
111	189	12.66	5170	2.1				
129	163	10.97	5040	2.5				
157	133	8.96	4740	2.5				
98	215	14.33	2790	0.95				
110	192	12.87	2810	1.05				
127	165	11.08	2820	1.15	FA	37	100L1-4	33
135	155	10.42	2810	1.20	FAF	37	100L1-4	35
157	134	8.97	2790	1.30	F	37	100L1-4	34
176	119	8.01	2770	1.40	FF	37	100L1-4	36
209	100	6.74	2630	1.40				
233	90	6.05	2590	1.50				
271	78	5.21	2540	1.60				



## 技术参数

## Technical Data

<b>P<sub>1</sub> = 2.2kW</b>								
------------------------------	--	--	--	--	--	--	--	--

NA rpm	M <sub>2</sub> Nm	i	Fr <sub>2</sub> MAX[N]	f <sub>s</sub>	Type	Gear unit	Motor size	 Kg
288	73	4.90	2520	1.65	FA	37	100L1-4	33
334	63	4.22	2460	1.75	FAF	37	100L1-4	35
374	56	3.77	2400	1.85	F	37	100L1-4	34
					FF	37	100L1-4	36

<b>P<sub>1</sub> = 3.0kW</b>								
------------------------------	--	--	--	--	--	--	--	--

1.2	22000	1169	86000	0.80				
1.5	17800	953	100800	1.00				
1.7	15700	845	106400	1.15				
1.8	14200	764	110000	1.25	FA	157 R97	100L2-4	780
2.1	12600	680	113000	1.45	FAF	157 R97	100L2-4	840
2.4	10600	576	116400	1.70	F	157 R97	100L2-4	800
3.1	8310	446	119400	2.2	FF	157 R97	100L2-4	910
4.6	5630	302	120000	3.2				
5.1	5070	273	120000	3.6				
6.0	4260	232	120000	4.2				
7.1	3620	197	120000	5.0				
					FA	127 R77	100L2-4	445
1.9	13800	727	87000	0.85	FAF	127 R77	100L2-4	485
2.2	12300	648	89800	0.95	F	127 R77	100L2-4	485
2.6	10500	549	90000	1.15	FF	127 R77	100L2-4	530
2.8	9410	495	90000	1.30				
					FA	107 R77	100L2-4	295
3.2	8300	436	48100	0.95	FAF	107 R77	100L2-4	315
3.8	7040	370	51500	1.10	F	107 R77	100L2-4	310
4.2	6340	333	53200	1.20	FF	107 R77	100L2-4	340
4.8	5540	291	55100	1.40				
					FA	107	132S-6	270
3.7	7750	254.40	49600	1.00	FAF	107	132S-6	290
4.4	6560	215.37	52700	1.15	F	107	132S-6	285
4.7	6070	199.31	53900	1.25	FF	107	132S-6	315
5.3	5440	178.64	55300	1.40				
					FA	107	100L2-4	260
5.5	5210	254.40	55900	1.50	FAF	107	100L2-4	280
6.5	4410	215.37	57600	1.75	F	107	100L2-4	275
7.0	4080	199.31	58300	1.90	FF	107	100L2-4	300
7.8	3660	178.64	59100	2.1				
8.7	3300	161.28	59800	2.3				



## 技术参数

## Technical Data

P <sub>1</sub> = 3.0kW								
N <sub>A</sub> rpm	M <sub>2</sub> Nm	i	Fr <sub>2</sub> MAX[N]	f <sub>s</sub>	Type	Gear unit	Motor size	 Kg
6.2	4580	223.88	29000	0.95	FA	97	100L2-4	180
7.4	3890	189.92	31100	1.10	FAF	97	100L2-4	205
8.0	3580	174.87	31900	1.20	F	97	100L2-4	190
					FF	97	100L2-4	220
9.0	3200	156.30	32800	1.35				
10	2880	140.71	33600	1.50	FA	97	100L2-4	180
11	2610	127.42	34200	1.65	FAF	97	100L2-4	205
12	2310	112.99	34800	1.85	F	97	100L2-4	190
14	2090	102.16	35200	2.1	FF	97	100L2-4	220
16	1840	89.85	35700	2.3				
10	2750	134.16	23900	1.10	FA	87	100L2-4	120
11	2520	123.29	24700	1.20	FAF	87	100L2-4	130
13	2240	109.49	25700	1.35	F	87	100L2-4	125
					FF	87	100L2-4	140
14	2000	97.89	26400	1.50				
16	1800	88.01	26900	1.65	FA	87	100L2-4	120
18	1560	76.39	26300	1.90	FAF	87	100L2-4	130
20	1400	68.40	25700	2.1	F	87	100L2-4	125
25	1160	56.75	24800	2.6	FF	87	100L2-4	140
28	1030	50.36	24100	2.9				
16	1750	85.52	13800	0.85	FA	77	100L2-4	78
19	1540	75.02	15500	1.00	FAF	77	100L2-4	85
21	1360	66.46	16600	1.10	F	77	100L2-4	82
					FF	77	100L2-4	93
24	1190	58.32	17500	1.25	FA	77	100L2-4	78
25	1130	55.27	17800	1.35	FAF	77	100L2-4	85
29	990	48.37	18300	1.50	F	77	100L2-4	82
32	890	43.58	18700	1.70	FF	77	100L2-4	93
37	780	38.23	19000	1.90				
38	750	36.58	19100	1.50	FA	77	100L2-4	77
44	645	31.51	19400	2.1	FAF	77	100L2-4	83
49	590	28.75	19500	2.4	F	77	100L2-4	81
55	520	25.50	19700	2.9	FF	77	100L2-4	91
65	440	21.43	19800	3.4				



技术参数

Technical Data

P <sub>1</sub> = 3.0kW								
N <sub>A</sub> rpm	M <sub>2</sub> Nm	i	Fr <sub>2</sub> MAX[N]	f <sub>s</sub>	Type	Gear unit	Motor size	 Kg
32	880	43.20	9690	0.95	FA	67	100L2-4	55
36	800	39.26	10500	0.95	FAF	67	100L2-4	62
41	695	34.01	11300	1.05	F	67	100L2-4	58
					FF	67	100L2-4	64
44	655	32.08	11600	1.25				
51	560	27.41	12100	1.45				
56	515	25.13	12300	1.60	FA	67	100L2-4	54
63	450	22.05	12600	1.80	FAF	67	100L2-4	61
67	430	20.90	12700	1.90	F	67	100L2-4	57
77	375	18.29	12900	2.2	FF	67	100L2-4	63
85	335	16.48	13000	2.4				
97	295	14.46	13000	2.8				
56	510	24.96	7440	1.15				
66	435	21.17	7340	1.40				
73	390	19.11	7260	1.55	FA	57	100L2-4	51
83	345	16.81	7140	1.75	FAF	57	100L2-4	56
88	325	15.88	7080	1.85	F	57	100L2-4	51
104	275	13.52	6890	2.2	FF	57	100L2-4	58
114	250	12.29	6780	2.4				
132	220	10.64	6590	2.8				
71	405	19.70	4750	1.00				
81	355	17.33	4760	1.15	FA	47	100L2-4	42
86	335	16.36	4760	1.20	FAF	47	100L2-4	44
100	285	13.93	4740	1.40	F	47	100L2-4	42
111	260	12.66	4700	1.55	FF	47	100L2-4	46
128	225	10.97	4640	1.80				
156	183	8.96	4370	1.80				
126	225	11.08	2320	0.85	FA	37	100L2-4	37
134	215	10.42	2350	0.85	FAF	37	100L2-4	39
156	184	8.97	2390	0.95	F	37	100L2-4	38
175	164	8.01	2410	1.05	FF	37	100L2-4	40
208	138	6.74	2290	1.00				
231	124	6.05	2300	1.10	FA	37	100L2-4	37
269	107	5.21	2290	1.15	FAF	37	100L2-4	39
286	100	4.90	2280	1.20	F	37	100L2-4	38
332	86	4.22	2250	1.25	FF	37	100L2-4	40
372	77	3.77	2220	1.35				



## 技术参数

## Technical Data

P <sub>1</sub> = 4.0kW								
N <sub>A</sub> rpm	M <sub>2</sub> Nm	i	Fr <sub>2</sub> MAX[N]	f <sub>s</sub>	Type	Gear unit	Motor size	 Kg
1.7	20800	845	90700	0.85				
1.9	18800	764	97800	0.95				
2.1	16700	680	103900	1.10				
2.5	14100	576	110100	1.30	FA	157 R97	112M-4	790
3.2	11000	446	115700	1.65	FAF	157 R97	112M-4	850
4.7	7460	302	120000	2.4	F	157 R97	112M-4	810
5.2	6720	273	120000	2.7	FF	157 R97	112M-4	920
6.1	5660	232	120000	3.2				
7.2	4800	197	120000	3.8				
<hr/>								
2.6	13800	549	87000	0.85	FA	127 R77	112M-4	455
2.9	12400	495	89700	0.95	FAF	127 R77	112M-4	490
3.3	10700	428	90000	1.10	F	127 R77	112M-4	490
3.8	9410	376	90000	1.30	FF	127 R77	112M-4	530
<hr/>								
4.3	8350	333	48000	0.90	FA	107 R77	112M-4	300
4.9	7300	291	50800	1.05	FAF	107 R77	112M-4	325
5.6	6400	255	53100	1.20	F	107 R77	112M-4	320
					FF	107 R77	112M-4	345
<hr/>								
4.2	9060	170.83	90000	1.30	FA	127	160M1-8	445
4.7	8150	153.67	90000	1.45	FAF	127	160M1-8	485
5.7	6650	125.37	90000	1.80	F	127	160M1-8	485
					FF	127	160M1-8	530
<hr/>								
5.6	6840	254.40	52000	1.10				
6.6	5790	215.37	54500	1.35				
7.1	5360	199.31	55500	1.45				
8.0	4810	178.64	56700	1.60	FA	107	112M-4	265
8.8	4340	161.28	57700	1.75	FAF	107	112M-4	285
9.7	3940	146.49	58500	1.95	F	107	112M-4	280
11	3500	129.97	59400	2.2	FF	107	112M-4	305
12	3170	117.94	60100	2.4				
14	2730	101.38	60900	2.8				
<hr/>								
8.1	4700	174.87	26600	0.90	FA	97	112M-4	190
9.1	4200	156.30	30200	1.00	FAF	97	112M-4	210
10	3780	140.71	31400	1.15	F	97	112M-4	195
11	3430	127.42	32300	1.25	FF	97	112M-4	230



## 技术参数

## Technical Data

P <sub>1</sub> = 4.0kW								
Na rpm	M <sub>2</sub> Nm	i	Fr <sub>2</sub> MAX[N]	f <sub>s</sub>	Type	Gear unit	Motor size	 Kg
13	3040	112.99	33200	1.40				
14	2750	102.16	33900	1.55				
15	2620	97.58	34100	1.65	FA	97	112M-4	190
16	2420	89.85	34600	1.80	FAF	97	112M-4	210
18	2160	80.31	35100	2.0	F	97	112M-4	195
20	1940	72.29	35500	2.2	FF	97	112M-4	230
22	1760	65.47	35800	2.4				
13	2950	109.49	21700	1.00	FA	87	112M-4	125
15	2630	97.89	24300	1.15	FAF	87	112M-4	135
16	2370	88.01	24600	1.25	F	87	112M-4	130
					FF	87	112M-4	145
19	2050	76.39	24200	1.45	FA	87	112M-4	125
21	1840	68.40	23900	1.65	FAF	87	112M-4	135
25	1530	56.75	23200	1.95	F	87	112M-4	130
28	1350	50.36	22800	2.2	FF	87	112M-4	145
31	1220	45.28	22300	2.3				
21	1790	66.46	13400	0.85	FA	77	112M-4	84
24	1570	58.32	15200	0.95	FAF	77	112M-4	91
26	1490	55.27	15800	1.00	F	77	112M-4	88
29	1300	48.37	16900	1.15	FF	77	112M-4	99
33	1170	43.58	17600	1.30	FA	77	112M-4	84
37	1030	38.23	18200	1.45	FAF	77	112M-4	91
42	910	33.74	18600	1.65	F	77	112M-4	88
47	800	29.91	19000	1.85	FF	77	112M-4	99
56	685	25.54	19300	2.1				
45	850	31.51	18800	1.65	FA	77	112M-4	83
49	775	28.75	19100	1.85	FAF	77	112M-4	89
56	685	25.50	19300	2.2	F	77	112M-4	87
66	575	21.43	19500	2.6	FF	77	112M-4	97
72	530	19.70	19600	2.8				
52	735	27.41	11000	1.10				
57	675	25.13	11400	1.20				
64	595	22.05	11900	1.40				
68	560	20.90	12100	1.45				
78	490	18.29	12400	1.65	FA	67	112M-4	61
86	445	16.48	12700	1.85	FAF	67	112M-4	68
98	390	14.46	12900	2.1	F	67	112M-4	64
111	345	12.76	13000	2.4	FF	67	112M-4	70
126	305	11.31	13000	2.7				
147	260	9.66	13000	3.2				
156	245	9.08	13000	2.2				
165	230	8.60	12800	2.5				





## 技术参数

## Technical Data

P <sub>1</sub> = 4.0kW								
N <sub>A</sub> rpm	M <sub>2</sub> Nm	i	Fr <sub>2</sub> MAX[N]	f <sub>s</sub>	Type	Gear unit	Motor size	 Kg
189	205	7.53	12400	3.0				
209	183	6.78	12100	3.4	FA	67	112M-4	61
239	160	5.95	11700	3.8	FAF	67	112M-4	68
270	141	5.25	11400	4.2	F	67	112M-4	64
305	125	4.66	11000	4.5	FF	67	112M-4	70
357	107	3.97	10600	4.7				
67	570	21.17	6490	1.05				
74	515	19.11	6490	1.15				
84	450	16.81	6450	1.35				
89	425	15.88	6430	1.40				
105	365	13.52	6340	1.65	FA	57	112M-4	58
116	330	12.29	6270	1.80	FAF	57	112M-4	63
133	285	10.64	6150	2.1	F	57	112M-4	58
153	250	9.31	5850	1.70	FF	57	112M-4	65
173	220	8.19	5730	1.90				
184	210	7.73	5680	2.0				
216	177	6.58	5510	2.4				
237	161	5.98	5410	2.6				
274	139	5.18	5250	3.0				
P <sub>1</sub> = 5.5kW								
2.5	19400	576	95800	0.95				
2.8	16900	503	103400	1.05				
3.2	15100	446	107800	1.20				
4.1	11800	353	114400	1.50	FA	157 R97	132S-4	800
4.7	10300	302	116900	1.75	FAF	157 R97	132S-4	850
5.2	9250	273	118300	1.95	F	157 R97	132S-4	820
6.2	7810	232	120000	2.3	FF	157 R97	132S-4	920
7.1	6790	202	120000	2.7				
7.3	6620	197	120000	2.7				
3.4	14200	418	86100	0.85				
3.8	12700	374	89000	0.95	FA	127 R87	132S-4	480
4.6	10600	312	90000	1.15	FAF	127 R87	132S-4	520
4.9	9950	293	90000	1.20	F	127 R87	132S-4	520
5.5	8780	259	90000	1.35	FF	127 R87	132S-4	560
6.4	7580	223	90000	1.60				
3.3	14700	428	85200	0.80	FA	127 R77	132S-4	460
3.8	12900	376	88700	0.95	FAF	127 R77	132S-4	495
					F	127 R77	132S-4	495
					FF	127 R77	132S-4	540



## 技术参数

## Technical Data

P <sub>1</sub> = 5.5kW								
Na rpm	M <sub>2</sub> Nm	i	Fr <sub>2</sub> MAX[N]	f <sub>s</sub>	Type	Gear unit	Motor size	 Kg
2.6	19800	267.43	94600	0.90				
3.3	16100	217.62	105500	1.10				
4.0	13200	178.20	111900	1.35				
4.4	12100	162.96	114000	1.50				
5.0	10500	141.80	116600	1.70	FA	157	160M2-8	710
5.7	9260	125.14	118300	1.95	FAF	157	160M2-8	770
6.5	8030	108.49	119700	2.2	F	157	160M2-8	730
7.4	7140	96.53	120000	2.5	FF	157	160M2-8	840
8.3	6350	85.80	120000	2.8				
9.1	5800	78.46	120000	3.1				
10	5050	68.28	120000	3.6				
4.2	12600	170.83	89200	0.95	FA	127	160M2-8	450
4.6	11400	153.67	90000	1.05	FAF	127	160M2-8	490
5.7	9270	125.37	90000	1.30	F	127	160M2-8	485
6.2	8460	114.34	90000	1.40	FF	127	160M2-8	530
6.6	7910	215.37	49200	0.95	FA	107	132S-4	270
7.2	7320	199.31	50800	1.05	FAF	107	132S-4	290
8.0	6560	178.64	52700	1.15	F	107	132S-4	285
8.9	5920	161.28	54200	1.30	FF	107	132S-4	315
9.8	5380	146.49	55500	1.45				
11	4770	129.97	56800	1.60				
12	4330	117.94	57700	1.75	FA	107	132S-4	270
14	3720	101.38	59000	2.1	FAF	107	132S-4	290
15	3400	92.47	59600	2.3	F	107	132S-4	285
16	3250	88.49	59900	2.4	FF	107	132S-4	315
17	3080	83.99	60200	2.5				
11	4680	127.42	27400	0.90	FA	97	132S-4	195
13	4150	112.99	30300	1.05	FAF	97	132S-4	215
14	3750	102.16	31400	1.15	F	97	132S-4	200
					FF	97	132S-4	235
15	3580	97.58	31900	1.20				
16	3300	89.85	32600	1.30				
17	3180	86.59	32900	1.35				
18	2950	80.31	33400	1.45	FA	97	132S-4	195
19	2780	75.63	33800	1.55	FAF	97	132S-4	215
20	2660	72.29	34100	1.60	F	97	132S-4	200
22	2400	65.47	34600	1.80	FF	97	132S-4	235
25	2130	58.06	34500	2.0				
27	1930	52.49	33900	2.2				
16	3230	88.01	5760	0.95	FA	87	132S-4	130
19	2810	76.39	21200	1.05	FAF	87	132S-4	140
21	2510	68.40	21200	1.20	F	87	132S-4	135
25	2080	56.75	21000	1.45	FF	87	132S-4	150



## 技术参数

## Technical Data

P <sub>1</sub> = 5.5kW								
N <sub>A</sub> rpm	M <sub>2</sub> Nm	i	Fr <sub>2</sub> MAX[N]	f <sub>s</sub>	Type	Gear unit	Motor size	 Kg
28	1850	50.36	20800	1.60	FA	87	132S-4	130
32	1660	45.28	20500	1.70	FAF	87	132S-4	140
36	1440	39.30	20100	1.90	F	87	132S-4	135
41	1290	35.19	19800	2.0	FF	87	132S-4	150
49	1070	29.20	19100	2.3				
42	1250	33.92	19700	2.1	FA	87	132S-4	125
50	1060	28.78	19100	2.3	FAF	87	132S-4	140
54	970	26.50	18800	3.1	F	87	132S-4	130
60	870	23.68	18400	3.5	FF	87	132S-4	145
30	1780	48.37	13500	0.85				
33	1600	43.58	15000	0.95	FA	77	132S-4	91
37	1400	38.23	16300	1.05	FAF	77	132S-4	98
42	1240	33.74	17300	1.20	F	77	132S-4	95
48	1100	29.91	17900	1.35	FF	77	132S-4	105
56	940	25.54	18500	1.55				
56	940	25.50	18500	1.60				
67	785	21.43	19000	1.90	FA	77	132S-4	90
73	725	19.70	19200	2.1	FAF	77	132S-4	96
82	645	17.49	19400	2.3	F	77	132S-4	94
91	575	15.64	19600	2.6	FF	77	132S-4	105
102	515	14.06	19300	2.9				
117	450	12.20	18600	3.4				
65	810	22.05	10400	1.00				
68	770	20.90	10800	1.05				
78	670	18.29	11500	1.20				
87	605	16.48	11900	1.35				
99	530	14.46	12300	1.55				
112	470	12.76	12500	1.75				
126	415	11.31	12800	1.95	FA	67	132S-4	66
148	355	9.66	12900	2.3	FAF	67	132S-4	73
158	335	9.08	12400	1.60	F	67	132S-4	69
166	315	8.60	12300	1.80	FF	67	132S-4	75
190	275	7.53	12000	2.2				
211	250	6.78	11700	2.5				
240	220	5.95	11400	2.8				
272	193	5.25	11100	3.1				
307	171	4.66	10700	3.3				
360	146	3.97	10300	3.4				
85	620	16.81	5450	0.95	FA	57	132S-4	63
90	585	15.88	5480	1.05	FAF	57	132S-4	68
106	495	13.52	5530	1.20	F	57	132S-4	63
116	450	12.29	5530	1.35	FF	57	132S-4	70
134	390	10.64	5510	1.55				



## 技术参数

## Technical Data

<b>P<sub>1</sub> = 5.5kW</b>								
------------------------------	--	--	--	--	--	--	--	--

NA rpm	M <sub>2</sub> Nm	i	Fr <sub>2</sub> MAX[N]	f <sub>s</sub>	Type	Gear unit	Motor size	 Kg
175	300	8.19	5190	1.40	FA	57	132S-4	63
185	285	7.73	5160	1.50	FAF	57	132S-4	68
217	240	6.58	5070	1.75	F	57	132S-4	63
239	220	5.98	5010	1.90	FF	57	132S-4	70
276	190	5.18	4900	2.2				

<b>P<sub>1</sub> = 7.5kW</b>								
------------------------------	--	--	--	--	--	--	--	--

4.6	14500	312	85500	0.85	FA	127 R87	132M-4	500
4.9	13600	293	87300	0.90	FAF	127 R87	132M-4	540
5.5	12000	259	90000	1.00	F	127 R87	132M-4	540
6.4	10400	223	90000	1.15	FF	127 R87	132M-4	580
7.2	9190	198	90000	1.30				
3.3	21600	217.62	87600	0.85				
4.0	17700	178.20	101100	1.00				
4.4	16200	162.96	105200	1.10				
5.1	14100	141.80	110100	1.30				
5.8	12400	125.14	113300	1.45				
6.6	10800	108.49	116100	1.65	FA	157	160L-8	740
7.5	9600	96.53	117800	1.85	FAF	157	160L-8	800
8.4	8530	85.80	119200	2.1	F	157	160L-8	760
9.2	7810	78.46	120000	2.3	FF	157	160L-8	870
11	6790	68.28	120000	2.7				
12	5990	60.25	120000	3.0				
14	5200	52.24	120000	3.5				
15	4620	46.48	120000	3.9				
18	3980	40.06	120000	4.5				
3.6	20000	267.43	94000	0.90				
4.4	16200	217.62	105100	1.10				
5.4	13300	178.20	111700	1.35				
5.9	12200	162.96	113800	1.50				
6.8	10600	141.80	116400	1.70				
7.7	9340	125.14	118200	1.95	FA	157	160M-6	710
8.8	8090	108.49	119700	2.2	FAF	157	160M-6	770
10	7200	96.53	120000	2.5	F	157	160M-6	730
11	6400	85.80	120000	2.8	FF	157	160M-6	840
12	5850	78.46	120000	3.1				
14	5090	68.28	120000	3.5				
16	4500	60.25	120000	4.0				
18	3900	52.24	119300	4.6				
5.7	12500	125.37	89500	0.95	FA	127	160L-8	485
6.3	11400	114.34	90000	1.05	FAF	127	160L-8	520
7.3	9840	98.95	90000	1.20	F	127	160L-8	520
8.2	8690	87.31	90000	1.40	FF	127	160L-8	570



## 技术参数

## Technical Data

P <sub>1</sub> = 7.5kW								
NA rpm	M <sub>2</sub> Nm	i	Fr <sub>2</sub> MAX[N]	f <sub>s</sub>	Type	Gear unit	Motor size	 Kg
5.6	12700	170.83	89000	0.95	FA	127	160M-6	450
6.2	11500	153.67	90000	1.05	FAF	127	160M-6	490
7.7	9350	125.37	90000	1.30	F	127	160M-6	485
8.4	8530	114.34	90000	1.40	FF	127	160M-6	530
8.4	8560	170.83	90000	1.40	FA	127	132M-4	435
9.3	7700	153.67	90000	1.55	FAF	127	132M-4	475
11	6280	125.37	90000	1.90	F	127	132M-4	475
					FF	127	132M-4	520
8.0	8950	178.64	46300	0.85	FA	107	132M-4	290
8.9	8080	161.28	48700	0.95	FAF	107	132M-4	310
9.8	7340	146.49	50700	1.05	F	107	132M-4	305
11	6510	129.97	52800	1.20	FF	107	132M-4	335
12	5910	117.94	54200	1.30				
14	5080	101.38	56100	1.50	FA	107	132M-4	290
15	4630	92.47	57100	1.65	FAF	107	132M-4	310
16	4430	88.49	57500	1.75	F	107	132M-4	305
17	4210	83.99	58000	1.85	FF	107	132M-4	335
19	3730	74.52	59000	2.1				
21	3390	67.62	59600	2.3				
15	4890	97.58	19300	0.90	FA	97	132M-4	215
16	4500	89.85	29300	0.95	FAF	97	132M-4	235
17	4340	86.59	29800	1.00	F	97	132M-4	220
18	4020	80.31	30700	1.05	FF	97	132M-4	255
19	3790	75.63	31300	1.15				
20	3620	72.29	31800	1.20				
22	3280	65.47	32200	1.30	FA	97	132M-4	215
25	2910	58.06	31800	1.50	FAF	97	132M-4	235
27	2630	52.49	31400	1.65	F	97	132M-4	220
32	2230	44.49	30600	1.95	FF	97	132M-4	255
37	1950	38.86	29900	2.2				
44	1630	32.50	28900	2.6				
33	2170	43.28	30500	1.40	FA	97	132M-4	210
39	1840	36.64	29600	1.65	FAF	97	132M-4	230
42	1700	33.91	29200	2.5	F	97	132M-4	215
47	1520	30.39	28500	2.8	FF	97	132M-4	250
25	2840	56.75	18100	1.05	FA	87	132M-4	150
28	2520	50.36	18200	1.15	FAF	87	132M-4	165
32	2270	45.28	18200	1.25	F	87	132M-4	155
36	1970	39.30	18100	1.40	FF	87	132M-4	170
41	1760	35.19	18000	1.50				
49	1460	29.20	17600	1.70				



## 技术参数

## Technical Data

P <sub>1</sub> = 7.5kW								
N <sub>A</sub> rpm	M <sub>2</sub> Nm	i	Fr <sub>2</sub> MAX[N]	f <sub>s</sub>	Type	Gear unit	Motor size	 Kg
50	1440	28.78	17600	1.70				
54	1330	26.50	17400	2.3				
60	1190	23.68	17100	2.5	FA	87	132M-4	150
67	1070	21.32	16800	2.8	FAF	87	132M-4	160
74	970	19.31	16500	3.1	F	87	132M-4	155
84	860	17.12	16200	3.5	FF	87	132M-4	170
92	775	15.48	15900	3.9				
42	1690	33.74	14300	0.90	FA	77	132M-4	110
48	1500	29.91	15700	1.00	FAF	77	132M-4	120
56	1280	25.54	17000	1.15	F	77	132M-4	115
					FF	77	132M-4	125
56	1280	25.50	17100	1.15				
67	1070	21.43	18000	1.40				
73	990	19.70	18400	1.50				
82	880	17.49	18800	1.70				
91	785	15.64	19000	1.90				
102	705	14.06	18600	2.1	FA	77	132M-4	110
117	610	12.20	18000	2.5	FAF	77	132M-4	115
131	545	10.93	17600	2.7	F	77	132M-4	115
154	465	9.30	16500	2.3	FF	77	132M-4	125
173	415	8.26	16100	2.6				
194	370	7.39	15700	2.9				
215	335	6.64	15300	3.3				
248	290	5.76	14800	3.7				
277	260	5.16	14500	4.2				
334	215	4.28	13800	4.7				
P <sub>1</sub> = 11kW								
4.8	20600	302	91800	0.90	FA	157 R97	160M-4	830
5.3	18600	273	98600	0.95	FAF	157 R97	160M-4	890
6.2	15700	232	106400	1.15	F	157 R97	160M-4	850
7.1	13700	202	110900	1.30	FF	157 R97	160M-4	960
7.3	13300	197	111700	1.35				
6.5	15200	223	84100	0.80	FA	127 R87	160M-4	510
7.3	13400	198	87700	0.90	FAF	127 R87	160M-4	550
8.7	11300	166	90000	1.05	F	127 R87	160M-4	550
					FF	127 R87	160M-4	600



## 技术参数

## Technical Data

P <sub>1</sub> = 11 kW								
NA rpm	M <sub>2</sub> Nm	i	Fr <sub>2</sub> MAX[N]	f <sub>s</sub>	Type	Gear unit	Motor size	 Kg
5.1	20700	141.80	91300	0.85	FA	157	180L-8	780
5.8	18300	125.14	99500	1.00	FAF	157	180L-8	840
6.6	15800	108.49	106100	1.15	F	157	180L-8	800
7.5	14100	96.53	110100	1.30	FF	157	180L-8	910
5.4	19500	178.20	95500	0.90				
5.9	17800	162.96	100800	1.00				
6.8	15500	141.80	106900	1.15	FA	157	160L-6	740
7.7	13700	125.14	110900	1.30	FAF	157	160L-6	800
8.8	11900	108.49	114300	1.50	F	157	160L-6	760
10	10600	96.53	116400	1.70	FF	157	160L-6	870
11	9390	85.80	118100	1.90				
12	8590	78.46	119100	2.1				
5.4	19500	267.43	95500	0.90				
6.6	15900	217.62	106000	1.15				
8.1	13000	178.20	112300	1.40				
8.8	11900	162.96	114300	1.50	FA	157	160M-4	710
10	10300	141.80	116800	1.75	FAF	157	160M-4	770
12	9130	125.14	118400	1.95	F	157	160M-4	730
13	7910	108.49	119900	2.3	FF	157	160M-4	840
15	7040	96.53	120000	2.6				
17	6260	85.80	118100	2.9				
18	5720	78.46	115700	3.1				
21	4980	68.28	112000	3.6				
7.7	13700	125.37	87100	0.85	FA	127	160L-6	485
8.4	12500	114.34	89500	0.95	FAF	127	160L-6	520
9.7	10800	98.95	90000	1.10	F	127	160L-6	520
11	9550	87.31	90000	1.25	FF	127	160L-6	570
13	8250	75.41	90000	1.45				
8.4	12500	170.83	89500	0.95	FA	127	160M-4	450
9.4	11200	153.67	90000	1.05	FAF	127	160M-4	490
11	9150	125.37	90000	1.30	F	127	160M-4	485
13	8340	114.34	90000	1.45	FF	127	160M-4	530
15	7220	98.95	90000	1.65				
16	6370	87.31	90000	1.90				
19	5500	75.41	88600	2.2				



## 技术参数

## Technical Data

P <sub>1</sub> = 11.0kW								
N <sub>A</sub> rpm	M <sub>2</sub> Nm	i	Fr <sub>2</sub> MAX[N]	f <sub>s</sub>	Type	Gear unit	Motor size	 Kg
12	8600	117.94	47300	0.90	FA	107	160M-4	305
14	7400	101.38	50600	1.05	FAF	107	160M-4	325
16	6750	92.47	52200	1.15	F	107	160M-4	320
					FF	107	160M-4	345
17	6130	83.99	53700	1.25				
19	5440	74.52	55300	1.40	FA	107	160M-4	305
21	4930	67.62	56500	1.55	FAF	107	160M-4	325
25	4240	58.12	56400	1.80	F	107	160M-4	320
28	3700	50.73	55100	2.1	FF	107	160M-4	345
33	3140	43.03	53500	2.5				
43	2470	33.79	51000	3.0	FA	107	160M-4	295
52	2010	27.57	48800	3.9	FAF	107	160M-4	315
57	1830	25.14	47800	4.3	F	107	160M-4	310
					FF	107	160M-4	335
22	4780	65.47	24000	0.90	FA	97	160M-4	230
25	4240	58.06	27100	1.00	FAF	97	160M-4	250
27	3830	52.49	27100	1.10	F	97	160M-4	235
					FF	97	160M-4	270
32	3250	44.49	27000	1.30	FA	97	160M-4	230
37	2830	38.86	26700	1.50	FAF	97	160M-4	250
44	2370	32.50	26200	1.80	F	97	160M-4	235
					FF	97	160M-4	270
42	2470	33.91	26400	1.75	FA	97	160M-4	225
47	2220	30.39	26000	1.95	FAF	97	160M-4	245
52	2000	27.44	25600	2.2	F	97	160M-4	230
58	1820	24.92	25200	2.4	FF	97	160M-4	265
65	1610	22.11	24700	2.7				





## 技术参数

## Technical Data

P <sub>1</sub> = 11.0kW								
N <sub>A</sub> rpm	M <sub>2</sub> Nm	i	Fr <sub>2</sub> MAX[N]	f <sub>s</sub>	Type	Gear unit	Motor size	 Kg
37	2870	39.30	14600	0.95	FA	87	160M-4	165
41	2570	35.19	14800	1.00	FAF	87	160M-4	175
49	2130	29.20	15000	1.20	F	87	160M-4	170
					FF	87	160M-4	185
54	1930	26.50	15000	1.55				
61	1730	23.68	15000	1.75	FA	87	160M-4	160
68	1560	21.32	14900	1.95	FAF	87	160M-4	175
75	1410	19.31	14800	2.1	F	87	160M-4	165
84	1250	17.12	14600	2.4	FF	87	160M-4	180
93	1130	15.48	14400	2.7				
110	960	13.12	14100	3.1				
73	1440	19.70	16100	1.05				
82	1280	17.49	17100	1.20				
92	1140	15.64	17600	1.30				
102	1030	14.06	17400	1.45				
118	890	12.20	17000	1.70	FA	77	160M-4	125
132	795	10.93	16700	1.90	FAF	77	160M-4	130
155	680	9.30	15500	1.60	F	77	160M-4	130
174	605	8.26	15200	1.80	FF	77	160M-4	140
195	540	7.39	14900	2.0				
217	485	6.64	14600	2.2				
250	420	5.76	14200	2.6				
279	375	5.16	13900	2.9				
336	310	4.28	13300	3.2				
P <sub>1</sub> = 15.0kW								
6.3	21200	232	89400	0.85	FA	157 R97	160L-4	870
7.2	18500	202	98800	0.95	FAF	157 R97	160L-4	930
7.4	18000	197	100400	1.00	F	157 R97	160L-4	890
					FF	157 R97	160L-4	1000
6.8	20900	141.80	90400	0.85	FA	157	180L-6	780
7.8	18500	125.14	98800	0.95	FAF	157	180L-6	840
8.9	16000	108.49	105700	1.10	F	157	180L-6	800
10	14300	96.53	109800	1.25	FF	157	180L-6	910
11	12700	85.80	112900	1.40				
6.7	21400	217.62	88800	0.85				
8.2	17500	178.20	101800	1.05	FA	157	160L-4	740
9.0	16000	162.96	105700	1.15	FAF	157	160L-4	800
10	13900	141.80	110500	1.30	F	157	160L-4	760
12	12300	125.14	113600	1.45	FF	157	160L-4	870
13	10600	108.49	116300	1.70				
15	9470	96.53	115800	1.90				



## 技术参数

## Technical Data

P <sub>1</sub> = 15.0kW								
Na rpm	M <sub>2</sub> Nm	i	Fr <sub>2</sub> MAX[N]	f <sub>s</sub>	Type	Gear unit	Motor size	 Kg
17	8420	85.80	113200	2.1	FA	157	160L-4	740
19	7700	78.46	111200	2.3	FAF	157	160L-4	800
21	6700	68.28	108000	2.7	F	157	160L-4	760
24	5910	60.25	105100	3.1	FF	157	160L-4	870
9.8	14600	98.95	85300	0.80	FA	127	180L-6	520
11	12900	87.31	88700	0.95	FAF	127	180L-6	560
13	11100	75.41	88300	1.10	F	127	180L-6	560
14	10300	70.07	87600	1.15	FF	127	180L-6	600
15	9440	63.91	86700	1.25				
12	12300	125.37	89000	1.00				
13	11200	114.34	88300	1.05	FA	127	160L-4	485
15	9710	98.95	87000	1.25	FAF	127	160L-4	520
17	8570	87.31	85600	1.40	F	127	160L-4	520
19	7400	75.41	83800	1.60	FF	127	160L-4	570
21	6870	70.07	82800	1.75				
16	9070	92.47	45900	0.85	FA	107	160L-4	345
17	8680	88.49	47100	0.90	FAF	107	160L-4	365
17	8240	83.99	48300	0.95	F	107	160L-4	360
20	7310	74.52	50800	1.05	FF	107	160L-4	390
22	6630	67.62	52500	1.15				
25	5700	58.12	52200	1.35	FA	107	160L-4	345
29	4980	50.73	51500	1.55	FAF	107	160L-4	365
34	4220	43.03	50400	1.80	F	107	160L-4	360
39	3690	37.61	49300	2.1	FF	107	160L-4	390
46	3120	31.80	48000	2.5				
43	3320	33.79	48500	2.2	FA	107	160L-4	335
53	2700	27.57	46700	2.9	FAF	107	160L-4	355
58	2470	25.14	45900	3.2	F	107	160L-4	350
67	2130	21.76	44500	3.7	FF	107	160L-4	380
33	4360	44.49	22900	1.00	FA	97	160L-4	270
38	3810	38.86	23100	1.15	FAF	97	160L-4	290
45	3190	32.50	23200	1.35	F	97	160L-4	275
					FF	97	160L-4	310
43	3330	33.91	23200	1.30				
48	2980	30.39	23200	1.45				
53	2690	27.44	23100	1.60				
59	2450	24.92	22900	1.75	FA	97	160L-4	265
66	2170	22.11	22600	2.0	FAF	97	160L-4	285
73	1970	20.07	22400	2.2	F	97	160L-4	270
85	1690	17.25	21900	2.5	FF	97	160L-4	305
97	1480	15.06	21400	2.9				
114	1250	12.77	20800	3.4				
131	1100	11.16	20200	3.7				



## 技术参数

## Technical Data

<b>P<sub>1</sub> = 15.0kW</b>								
-------------------------------	--	--	--	--	--	--	--	--

NA rpm	M <sub>2</sub> Nm	i	Fr <sub>2</sub> MAX[N]	f <sub>s</sub>	Type	Gear unit	Motor size	 Kg
55	2600	26.50	12300	1.15				
62	2320	23.68	12600	1.30				
68	2090	21.32	12700	1.45				
76	1890	19.31	12800	1.60				
85	1680	17.12	12900	1.80				
94	1520	15.48	12800	2.0				
111	1290	13.12	12700	2.3	FA	87	160L-4	200
127	1120	11.46	12600	2.7	FAF	87	160L-4	215
152	940	9.58	12300	3.1	F	87	160L-4	205
176	810	8.29	11700	1.90	FF	87	160L-4	220
199	720	7.35	11500	2.1				
220	650	6.65	11300	2.4				
259	555	5.63	11000	2.8				
297	485	4.92	10700	3.2				
355	405	4.12	10300	3.6				

<b>P<sub>1</sub> = 18.5kW</b>								
-------------------------------	--	--	--	--	--	--	--	--

7.2	22800	202	70200	0.80	FA	157 R97	180M-4	890
7.5	22100	197	83800	0.80	FAF	157 R97	180M-4	950
					F	157 R97	180M-4	910
					FF	157 R97	180M-4	1020
<hr/>								
8.2	21500	178.20	88200	0.85				
9.0	19700	162.96	95000	0.90				
10	17100	141.80	102800	1.05				
12	15100	125.14	107900	1.20				
14	13100	108.49	112100	1.40	FA	157	180M-4	770
15	11600	96.53	111300	1.55	FAF	157	180M-4	820
17	10300	85.80	109300	1.75	F	157	180M-4	790
19	9460	78.46	107600	1.90	FF	157	180M-4	890
21	8230	68.28	104900	2.2				
24	7270	60.25	102300	2.5				
28	6300	52.24	99300	2.9				
<hr/>								
13	13800	114.34	82200	0.85				
15	11900	98.95	81700	1.00				
17	10500	87.31	80900	1.15	FA	127	180M-4	510
19	9090	75.41	79700	1.30	FAF	127	180M-4	550
21	8450	70.07	79000	1.40	F	127	180M-4	550
23	7710	63.91	78100	1.55	FF	127	180M-4	590
26	6670	55.31	76400	1.80				
30	5880	48.80	74900	2.0				



## 技术参数

## Technical Data

P <sub>1</sub> = 18.5kW								
NA rpm	M <sub>2</sub> Nm	i	Fr <sub>2</sub> MAX[N]	f <sub>s</sub>	Type	Gear unit	Motor size	 Kg
20	8990	74.52	46200	0.85	FA	107	180M-4	365
22	8150	67.62	48500	0.95	FAF	107	180M-4	385
25	7010	58.12	48700	1.10	F	107	180M-4	380
29	6120	50.73	48400	1.25	FF	107	180M-4	410
34	5190	43.03	47700	1.50	FA	107	180M-4	365
39	4540	37.61	47000	1.70	FAF	107	180M-4	385
46	3830	31.80	46000	2.0	F	107	180M-4	380
					FF	107	180M-4	410
43	4070	33.79	46400	1.80	FA	107	180M-4	355
53	3320	27.57	45000	2.4	FAF	107	180M-4	375
58	3030	25.14	44300	2.6	F	107	180M-4	370
67	2620	21.76	43200	3.0	FF	107	180M-4	400
38	4690	38.86	20000	0.90	FA	97	180M-4	290
45	3920	32.50	20600	1.10	FAF	97	180M-4	315
					F	97	180M-4	300
					FF	97	180M-4	330
53	3310	27.44	20900	1.30				
59	3010	24.92	20900	1.45				
66	2670	22.11	20900	1.60	FA	97	180M-4	285
73	2420	20.07	20800	1.80	FAF	97	180M-4	305
85	2080	17.25	20500	2.1	F	97	180M-4	295
97	1820	15.06	20200	2.4	FF	97	180M-4	325
115	1540	12.77	19800	2.8				
131	1350	11.16	19300	3.1				
69	2570	21.32	10900	1.15				
76	2330	19.31	11100	1.30				
86	2060	17.12	11400	1.45				
95	1870	15.48	11500	1.60				
112	1580	13.12	11600	1.90	FA	87	180M-4	225
128	1380	11.46	11600	2.2	FAF	87	180M-4	235
153	1160	9.58	11500	2.5	F	87	180M-4	230
177	1000	8.29	10900	1.55	FF	87	180M-4	245
199	890	7.35	10800	1.75				
220	800	6.65	10700	1.90				
260	680	5.63	10400	2.3				
298	595	4.92	10200	2.6				
356	495	4.12	9900	2.9				
P <sub>1</sub> = 22kW								
10	20900	96.53	90500	0.85	FA	157	200L2-6	860
11	18600	85.80	98500	0.95	FAF	157	200L2-6	920
12	17000	78.46	103100	1.05	F	157	200L2-6	880
14	14800	68.28	107700	1.20	FF	157	200L2-6	990



## 技术参数

## Technical Data

P <sub>1</sub> = 22kW								
NA rpm	M <sub>2</sub> Nm	i	Fr <sub>2</sub> MAX[N]	f <sub>s</sub>	Type	Gear unit	Motor size	 Kg
10	20300	141.80	92600	0.90				
12	17900	125.14	100400	1.00				
14	15600	108.49	106800	1.15				
15	13800	96.53	106900	1.30				
17	12300	85.80	105400	1.45	FA	157	180L-4	780
19	11300	78.46	104000	1.60	FAF	157	180L-4	840
21	9790	68.28	101700	1.85	F	157	180L-4	800
24	8640	60.25	99600	2.1	FF	157	180L-4	910
28	7490	52.24	97000	2.4				
32	6660	46.48	94800	2.7				
37	5740	40.06	91900	3.1				
45	4670	32.55	87800	3.9				
15	14200	98.95	76400	0.85				
17	12500	87.31	76300	0.95				
19	10800	75.41	75700	1.10	FA	127	180L-4	520
21	10000	70.07	75300	1.20	FAF	127	180L-4	560
23	9160	63.91	74700	1.30	F	127	180L-4	560
26	7930	55.31	73500	1.50	FF	127	180L-4	600
30	7000	48.80	72300	1.70				
35	6040	42.15	70700	2.0				
25	8330	58.12	45200	0.90	FA	107	180L-4	380
29	7280	50.73	45300	1.05	FAF	107	180L-4	400
34	6170	43.03	45100	1.25	F	107	180L-4	395
					FF	107	180L-4	425
39	5390	37.61	44800	1.40	FA	107	180L-4	380
46	4560	31.80	44100	1.70	FAF	107	180L-4	400
					F	107	180L-4	395
					FF	107	180L-4	425
43	4850	33.79	44300	1.55				
53	3950	27.57	43300	2.0	FA	107	180L-4	370
58	3610	25.14	42800	2.2	FAF	107	180L-4	390
67	3120	21.76	41900	2.5	F	107	180L-4	385
76	2750	19.20	41000	2.9	FF	107	180L-4	415
53	3940	27.44	18700	1.10				
59	3570	24.92	18900	1.20				
66	3170	22.11	19100	1.35	FA	97	180L-4	300
73	2880	20.07	19200	1.50	FAF	97	180L-4	320
85	2470	17.25	19100	1.75	F	97	180L-4	305
97	2160	15.06	19000	2.0	FF	97	180L-4	340
115	1830	12.77	18700	2.4				
131	1600	11.16	18400	2.6				



## 技术参数

## Technical Data

<b>P<sub>1</sub> = 22kW</b>								
-----------------------------	--	--	--	--	--	--	--	--

<b>N<sub>A</sub></b> rpm	<b>M<sub>2</sub></b> Nm	<b>i</b>	<b>Fr<sub>2MAX</sub>[N]</b>	<b>f<sub>s</sub></b>	<b>Type</b>	<b>Gear unit</b>	<b>Motor size</b>	 Kg
69	3060	21.32	8990	1.00				
76	2770	19.31	9430	1.10				
86	2460	17.12	9850	1.20				
95	2220	15.48	10100	1.35				
112	1880	13.12	10400	1.60				
128	1640	11.46	10600	1.85	FA	87	180L-4	235
153	1370	9.58	10600	2.1	FAF	87	180L-4	250
177	1190	8.29	10100	1.30	F	87	180L-4	240
199	1050	7.35	10100	1.45	FF	87	180L-4	260
220	950	6.65	10000	1.60				
260	810	5.63	9900	1.90				
298	705	4.92	9750	2.2				
356	590	4.12	9500	2.5				

<b>P<sub>1</sub> = 30kW</b>								
-----------------------------	--	--	--	--	--	--	--	--

14	21100	108.49	89600	0.85				
15	18800	96.53	96900	0.95				
17	16700	85.80	96400	1.10				
19	15300	78.46	95800	1.20	FA	157	200L-4	860
22	13300	68.28	94600	1.35	FAF	157	200L-4	920
24	11700	60.25	93300	1.55	F	157	200L-4	880
28	10200	52.24	91500	1.75	FF	157	200L-4	990
32	9060	46.48	89900	2.0				
37	7810	40.06	87700	2.3				
19	14700	75.41	66600	0.80				
21	13700	70.07	66800	0.90				
23	12500	63.91	66900	0.95				
27	10800	55.31	66700	1.10	FA	127	200L-4	610
30	9510	48.80	66300	1.25	FAF	127	200L-4	650
35	8210	42.15	65500	1.45	F	127	200L-4	650
39	7270	37.28	64700	1.65	FF	127	200L-4	690
47	6110	31.33	63200	1.95				
58	4930	25.30	61200	2.4				
55	5240	26.86	61800	1.60	FA	127	200L-4	600
60	4790	24.57	60900	1.80	FAF	127	200L-4	630
69	4170	21.38	59400	2.9	F	127	200L-4	630
78	3680	18.87	58000	3.0	FF	127	200L-4	680
34	8390	43.03	39200	0.90	FA	107	200L-4	465
39	7330	37.61	39600	1.05	FAF	107	200L-4	485
46	6200	31.80	39700	1.25	F	107	200L-4	480
					FF	107	200L-4	510



## 技术参数

## Technical Data

P <sub>1</sub> = 30kW								
N <sub>A</sub> rpm	M <sub>2</sub> Nm	i	Fr <sub>2</sub> MAX[N]	f <sub>s</sub>	Type	Gear unit	Motor size	 Kg
53	5370	27.57	39500	1.45				
58	4900	25.14	39300	1.60				
68	4240	21.76	38800	1.85	FA	107	200L-4	455
77	3740	19.20	38300	2.1	FAF	107	200L-4	475
89	3230	16.58	37600	2.4	F	107	200L-4	470
100	2860	14.67	36900	2.7	FF	107	200L-4	495
119	2400	12.33	35900	2.9				
148	1940	9.96	34500	3.4				
<hr/>								
66	4310	22.11	15100	1.00				
73	3910	20.07	15500	1.10				
85	3360	17.25	16000	1.30				
98	2930	15.06	16300	1.45				
115	2490	12.77	16400	1.75	FA	97	200L-4	380
132	2180	11.16	16400	1.90	FAF	97	200L-4	405
162	1770	9.06	15400	1.35	F	97	200L-4	390
179	1600	8.22	15300	1.45	FF	97	200L-4	420
208	1380	7.07	15100	1.70				
238	1200	6.17	14900	1.85				
281	1020	5.23	14600	2.1				
321	890	4.57	14300	2.3				
<hr/>								
P <sub>1</sub> = 37kW								
17	20600	85.80	88600	0.85				
19	18900	78.46	88700	0.95				
22	16400	68.28	88400	1.10				
24	14500	60.25	87800	1.25	FA	157	225S-4	910
28	12600	52.24	86800	1.45	FAF	157	225S-4	970
32	11200	46.48	85700	1.60	F	157	225S-4	930
37	9630	40.06	84000	1.85	FF	157	225S-4	1040
45	7820	32.55	81400	2.3				
53	6630	27.60	79100	2.7				
<hr/>								
27	13300	55.31	60900	0.90				
30	11700	48.80	61100	1.00	FA	127	225S-4	660
35	10100	42.15	61100	1.20	FAF	127	225S-4	690
39	8960	37.28	60700	1.35	F	127	225S-4	690
47	7530	31.33	59900	1.60	FF	127	225S-4	740
58	6080	25.30	58500	1.95				
<hr/>								
55	6460	26.86	58900	1.30				
60	5910	24.57	58300	1.45	FA	127	225S-4	650
69	5140	21.38	57100	2.3	FAF	127	225S-4	680
78	4530	18.87	56000	2.4	F	127	225S-4	680
90	3930	16.36	54600	2.8	FF	127	225S-4	730



## 技术参数

## Technical Data

<b>P<sub>1</sub> = 37kW</b>								
-----------------------------	--	--	--	--	--	--	--	--

N <sub>A</sub> rpm	M <sub>2</sub> Nm	i	Fr <sub>2</sub> MAX[N]	f <sub>s</sub>	Type	Gear unit	Motor size	Kg
101	3500	14.55	53400	3.1	FA FAF F FF	127	225S-4	650 680 680 730
117	3010	12.54	51900	3.3				
144	2450	10.19	49600	3.9				
166	2130	8.86	47700	3.3				
186	1890	7.88	46500	3.2				
53	6630	27.57	36200	1.20	FA FAF F FF	107	225S-4	500 520 520 550 500 520 520 550
58	6040	25.14	36200	1.30				
68	5230	21.76	36200	1.50				
77	4610	19.20	36000	1.70				
89	3990	16.58	35600	1.95				
100	3530	14.67	35100	2.2				
119	2960	12.33	34400	2.4				
148	2390	9.96	33300	2.7				
152	2330	9.69	32400	2.1				
176	2010	8.37	31700	2.4				
199	1780	7.40	31000	2.6				
236	1500	6.22	30000	3.1				

<b>P<sub>1</sub> = 45kW</b>								
-----------------------------	--	--	--	--	--	--	--	--

22	20000	68.28	81300	0.90	FA FAF F FF	157	225M-4	940 1000 960 1070
24	17600	60.25	81600	1.00				
28	15300	52.24	81300	1.20				
32	13600	46.48	80900	1.30				
37	11700	40.06	79900	1.55				
45	9510	32.55	78000	1.90				
53	8070	27.60	76200	2.2				
30	14300	48.80	55200	0.85	FA FAF F FF	127	225M-4	690 720 720 770
35	12300	42.15	56000	0.95				
39	10900	37.28	56200	1.10				
47	9160	31.33	56100	1.30				
58	7400	25.30	55400	1.60				
55	7850	26.86	55700	1.10	FA FAF F FF	127	225M-4	670 710 710 760 670 710 710 760
60	7180	24.57	55300	1.20				
69	6250	21.38	54500	1.90				
78	5520	18.87	53700	2.0				
90	4780	16.36	52600	2.3				
101	4250	14.55	51600	2.6				
117	3670	12.54	50300	2.7				
144	2980	10.19	48400	3.2				
166	2590	8.86	46600	2.7				
186	2300	7.88	45500	2.6				
216	1990	6.80	44000	3.5				
266	1610	5.52	42000	3.7				





## 技术参数

## Technical Data

<b>P<sub>1</sub> = 45kW</b>								
-----------------------------	--	--	--	--	--	--	--	--

<b>N<sub>A</sub></b> rpm	<b>M<sub>2</sub></b> Nm	<b>i</b>	<b>Fr<sub>2</sub>MAX[N]</b>	<b>f<sub>s</sub></b>	<b>Type</b>	<b>Gear unit</b>	<b>Motor size</b>	 Kg
53	8060	27.57	32400	0.95				
58	7350	25.14	32800	1.05				
68	6360	21.76	33200	1.25				
77	5610	19.20	33300	1.40				
89	4850	16.58	33300	1.60	FA	107	225M-4	530
100	4290	14.67	33100	1.80	FAF	107	225M-4	550
119	3600	12.33	32700	1.95	F	107	225M-4	550
148	2910	9.96	31900	2.2	FF	107	225M-4	570
152	2830	9.69	31000	1.75				
176	2450	8.37	30400	1.95				
199	2160	7.40	29900	2.1				
236	1820	6.22	29100	2.5				

<b>P<sub>1</sub> = 55kW</b>								
-----------------------------	--	--	--	--	--	--	--	--

24	21500	60.25	73800	0.85				
28	18600	52.24	74600	0.95	FA	157	250M-4	1070
32	16500	46.48	74800	1.10	FAF	157	250M-4	1130
37	14300	40.06	74700	1.25	F	157	250M-4	1090
45	11600	32.55	73800	1.55	FF	157	250M-4	1200
53	9830	27.60	72600	1.85				
<hr/>								
52	10200	28.60	72900	1.65	FA	157	250M-4	1060
58	9060	25.43	71900	1.65	FAF	157	250M-4	1120
67	7890	22.16	70600	2.3	F	157	250M-4	1080
75	7040	19.77	69400	2.4	FF	157	250M-4	1190
88	6000	16.85	67600	3.0				
<hr/>								
40	13300	37.28	50600	0.90	FA	127	250M-4	810
47	11200	31.33	51400	1.10	FAF	127	250M-4	850
58	9010	25.30	51600	1.35	F	127	250M-4	840
					FF	127	250M-4	890
<hr/>								
69	7610	21.38	51300	1.60				
78	6720	18.87	50800	1.65				
90	5820	16.36	50100	1.90				
101	5180	14.55	49400	2.1	FA	127	250M-4	800
118	4470	12.54	48400	2.2	FAF	127	250M-4	830
145	3630	10.19	46800	2.6	F	127	250M-4	830
166	3160	8.86	45100	2.2	FF	127	250M-4	880
187	2810	7.88	44200	2.1				
217	2420	6.80	42900	2.9				
267	1970	5.52	41100	3.1				
315	1670	4.68	39600	3.6				



## 技术参数

## Technical Data

P <sub>1</sub> = 75kW								
N <sub>A</sub> rpm	M <sub>2</sub> Nm	i	Fr <sub>2</sub> MAX[N]	f <sub>s</sub>	Type	Gear unit	Motor size	 Kg
32	22500	46.48	62900	0.80	FA	157	280S-4	1200
37	19400	40.06	64400	0.95	FAF	157	280S-4	1260
45	15800	32.55	65400	1.15	F	157	280S-4	1220
54	13400	27.60	65500	1.35	FF	157	280S-4	1330
52	13800	28.60	65500	1.25				
58	12300	25.43	65400	1.20	FA	157	280S-4	1190
67	10700	22.16	64900	1.70	FAF	157	280S-4	1250
75	9570	19.77	64300	1.80	F	157	280S-4	1220
88	8150	16.85	63200	2.2	FF	157	280S-4	1320
106	6760	13.96	61600	2.5				
124	5770	11.92	60100	2.8				
58	12200	25.30	44000	1.00	FA	127	280S-4	950
					FAF	127	280S-4	980
					F	127	280S-4	980
					FF	127	280S-4	1030
69	10300	21.38	44800	1.15				
78	9130	18.87	45100	1.20	FA	127	280S-4	940
90	7920	16.36	45200	1.40	FAF	127	280S-4	970
102	7040	14.55	45000	1.55	F	127	280S-4	970
118	6070	12.54	44600	1.65	FF	127	280S-4	1020
145	4930	10.19	43700	1.95				
167	4290	8.86	42200	1.65				
188	3810	7.88	41600	1.55				
218	3290	6.80	40700	2.1				
268	2670	5.52	39300	2.3				
316	2270	4.68	38100	2.7				
P <sub>1</sub> = 90kW								
45	18900	32.55	59100	0.95	FA	157	280M-4	1280
54	16000	27.60	60200	1.10	FAF	157	280M-4	1330
					F	157	280M-4	1300
					FF	157	280M-4	1400
52	16600	28.60	60000	1.00				
58	14800	25.43	60400	1.00	FA	157	280M-4	1270
67	12900	22.16	60600	1.40	FAF	157	280M-4	1330
75	11500	19.77	60500	1.50	F	157	280M-4	1290
88	9790	16.85	59900	1.85	FF	157	280M-4	1400
106	8110	13.96	58900	2.1				
124	6920	11.92	57800	2.3				
58	14700	25.30	33100	0.80	FA	127	280M-4	1020
					FAF	127	280M-4	1060
					F	127	280M-4	1060
					FF	127	280M-4	1100



## 技术参数

## Technical Data

P <sub>1</sub> = 90kW								
N <sub>A</sub> rpm	M <sub>2</sub> Nm	i	Fr <sub>2</sub> MAX[N]	f <sub>s</sub>	Type	Gear unit	Motor size	 Kg
69	12400	21.38	38800	0.95				
78	11000	18.87	40900	1.00				
90	9500	16.36	41500	1.15				
102	8450	14.55	41700	1.30				
118	7280	12.54	41800	1.35	FA	127	280M-4	1010
145	5920	10.19	41400	1.60	FAF	127	280M-4	1050
167	5150	8.86	40100	1.35	F	127	280M-4	1050
188	4580	7.88	39700	1.30	FF	127	280M-4	1090
218	3950	6.80	39000	1.75				
268	3210	5.52	37900	1.85				
316	2720	4.68	36900	2.2				
P <sub>1</sub> = 110kW								
54	19500	27.60	53100	0.90	FA	157	315S-4	1460
					FAF	157	315S-4	1520
					F	157	315S-4	1480
					FF	157	315S-4	1590
67	15700	22.16	54900	1.15	FA	157	315S-4	1460
75	14000	19.77	55400	1.20	FAF	157	315S-4	1520
88	11900	16.85	55600	1.50	F	157	315S-4	1480
106	9880	13.96	55300	1.70	FF	157	315S-4	1580
125	8430	11.92	54700	1.90				
P <sub>1</sub> = 132kW								
67	18800	22.16	48700	0.95	FA	157	315M1-4	1560
75	16800	19.77	49800	1.00	FAF	157	315M1-4	1620
88	14300	16.85	50900	1.25	F	157	315M1-4	1580
106	11900	13.96	51400	1.45	FF	157	315M1-4	1680
125	10100	11.92	51400	1.60				
P <sub>1</sub> = 160kW								
88	17300	16.85	44800	1.05	FA	157	315M2-4	1560
106	14400	13.96	46400	1.20	FAF	157	315M2-4	1620
125	12300	11.92	47100	1.30	F	157	315M2-4	1580
					FF	157	315M2-4	1680
P <sub>1</sub> = 200kW								
88	21700	16.85	36100	0.85	FA	157	315L1-4	1560
106	18000	13.96	39200	0.95	FAF	157	315L1-4	1620
125	15300	11.92	41000	1.05	F	157	315L1-4	1580
					FF	157	315L1-4	1680